



SANTALUZIA®

SUSTENTABILIDADE POR PRINCÍPIO

Sustainability by principle | Sustentabilidad por principio



Santa Luzia: Sustentabilidade por princípio

Sustainability by principle | Sustentabilidade por princípio





Vivemos uma nova era. Uma era em que se torna urgente e imprescindível a ressignificação de posturas socioambientais em processos de produção. Nesse mesmo contexto, um número cada vez maior de indivíduos deseja fazer parte de um movimento de transformação global, repensando seus papéis como consumidores ou como profissionais dos mercados em que atuam.

Nos últimos 15 anos, temos aceitado o desafio de encontrar soluções economicamente viáveis e responsáveis com o meio ambiente. Investimos em pesquisa e desenvolvimento para construir 7 unidades de reciclagem em Braço do Norte, Santa Catarina e outros estados com capacidade para recuperar mais de 1000 toneladas de resíduos por mês.

Além de contribuir para reduzir os impactos da degradação ambiental por meio da reciclagem de resíduos, a Santa Luzia conseguiu dar um salto com seu modelo comercial. Porque produtos feitos de material reciclado possuem atributos cada vez mais valorizados pelas atuais e futuras gerações, que acreditam em sua responsabilidade e compromissos para a construção de um bem maior.

We are living a new era. An era in which it becomes urgent and essential the re-signification of socio-environmental positions in production processes. In this same context, an increasing number of individuals wish to be part of a global transformation movement, rethinking their roles as consumers or as professionals in the markets in which they operate.

In the last 15 years, we have accepted the challenge of finding economically viable and responsible solutions with the environment. We invested in research and development to build 7 recycling facilities in Braço do Norte, Santa Catarina and other states with the capacity to recover more than 1000 tons of waste per month.

In addition to contributing to reduce the impacts of environmental degradation through waste recycling, Santa Luzia was able to make a jump with its commercial model. Since products made from recycled material have attributes that are increasingly valued by current and future generations, who believe in their responsibility and commitment to building a greater good.

Estamos viviendo una nueva era. Una era en la que se hace urgente y esencial la resignificación de las posiciones socio ambientales en los procesos de producción. En este mismo contexto, cada vez más personas desean formar parte de un movimiento de transformación global, reconsiderando sus roles como consumidores o como profesionales en los mercados en que los operan.

En los últimos 15 años, hemos aceptado el desafío de encontrar soluciones económicamente viables y responsables con el medioambiente. Invertimos en investigación y desarrollo para construir 7 instalaciones de reciclaje en Braço do Norte, Santa Catarina y otros estados con la capacidad de recuperar más de 1000 toneladas de desechos por mes.

Además de contribuir a reducir los impactos de la degradación ambiental a través del reciclaje de residuos, Santa Luzia pudo dar un salto con su modelo comercial. Dado que los productos hechos de material reciclado tienen atributos que son cada vez más valorados por las generaciones actuales y futuras, que creen en su responsabilidad y compromiso para construir un bien mayor.

Impactos positivos no meio ambiente

Positive impacts on the environment | Impactos positivos en el medio ambiente

- Já reciclamos o equivalente a 83 mil carretas de resíduos como o EPS (Isopor®) e o poliuretano. Um modelo de desenvolvimento que causa um impacto positivo real na natureza.
- Ao desenvolver nossos produtos com matéria-prima 100% reciclada, deixamos de derrubar mais de 893 mil árvores.
- Santa Luzia já acumula o correspondente a 1624 campos de futebol de resíduos transformados em matéria-prima para produtos de design e decoração.
- Em nosso parque fabril, a matéria-prima descartada durante a produção é reincorporada ao processo, criando um ciclo infinito de reaproveitamento que não causa danos ao meio ambiente.

• We have already recycled the equivalent of 83 thousand waste carts of residues such as EPS and polyurethane. A development model that has a real positive impact on nature.

• By developing our products with 100% recycled raw material, we stopped overthrowing more than 893 thousand trees.

• Santa Luzia already accumulates the corresponding to 1624 soccer fields of waste transformed into raw material for design and decoration products.

• In our factory, the raw material discarded during production is reincorporated into the process, creating an infinite cycle of reuse that does not cause damage to the environment.

• Ya hemos reciclado el equivalente a 83 mil carretas de residuos como EPS y poliuretano. Un modelo de desarrollo que tiene un impacto positivo real en la naturaleza.

• Al desarrollar nuestros productos con materia prima 100% reciclada, dejamos de cortar más de 893 mil árboles.

• Santa Luzia ya acumula el equivalente a 1624 campos de fútbol de desechos transformados en materia prima para productos de diseño y decoración.

• En nuestra fábrica, la materia prima descartada durante la producción se reincorpora al proceso, creando un ciclo infinito de reutilización que no causa daños al medio ambiente.

Por que a Santa Luzia é a sua melhor escolha?

Why Santa Luzia is your best choice?
¿Por qué Santa Luzia es tu mejor opción?



Fabricação responsável

A Santa Luzia se preocupa com o desenvolvimento sustentável do planeta, por isso buscamos constantemente a otimização de nossos produtos e processos em busca de melhorar nosso desempenho ambiental. O uso de matéria-prima reciclada foi uma estratégia que encontramos para contribuir com a redução de descarte de poliestireno em aterros sanitários.

Responsible Manufacturing

Santa Luzia is concerned with the planet sustainable development; therefore, we are constantly seeking to optimize our products and processes in order to improve our environmental performance. The use of recycled raw materials was a strategy that we found to contribute with the reduction of polystyrene disposal in landfills.

Fabricación Responsable

Santa Luzia se preocupa por el desarrollo sostenible del planeta; por lo tanto, estamos constantemente buscando optimizar nuestros productos y procesos para mejorar nuestro desempeño ambiental. El uso de materias primas recicladas fue una estrategia que encontramos para contribuir con la reducción de la eliminación de poliestireno en vertederos.

Conteúdo reciclado e reciclável

Nossos perfis são fabricados com 96% de poliestireno reciclado e são 100% recicláveis.

Recycled and Recyclable Content

Our profiles are manufactured with 96% recycled polystyrene and are 100% recyclable.

Contenido reciclado y reciclable

Nuestros perfiles están fabricados con 96% de poliestireno reciclado y son 100% reciclables.

Logística Reversa

A Santa Luzia oferece e encoraja os clientes a enviarem sobras de instalação e descarte dos perfis de poliestireno para que possamos utilizar novamente no processo produtivo, pois o produto é 100% reciclável.

Reverse Logistics

Santa Luzia offers and encourages customers to send back leftovers from the installation and disposal of polystyrene profiles in order to use them again in the production process, since the product is 100% recyclable.

Logística Inversa

Santa Luzia ofrece y alienta a los clientes a que envíen de vuelta los restos de la instalación y eliminación de perfiles de poliestireno para que podamos volver a utilizarlos en el proceso de producción, ya que el producto es 100% reciclable.

Baixo VOC

Entendemos que materiais saudáveis contribuem para a qualidade de vida das pessoas que ocupam os ambientes. Nossos perfis foram testados e aprovados de acordo com o Departamento de Saúde Pública da Califórnia (CDPH), norma V1.1 (2010). Por isso contribuem para pontuação em projetos LEED na categoria de Qualidade do Ambiente Interno.

INFORMAÇÕES: COV - COMPOSTOS ORGÂNICOS VOLÁTEIS

Produto Product Producto	COV
Perfis de Poliestireno Polystyrene Profiles Perfiles de poliestireno	COV = 2,87 g/L
Cola Santa Luzia Santa Luzia Glue Pegamento Santa Luzia	COV = 4,95 g/L
Super Adesivo Santa Luzia Heavy Duty Adhesive Super Pegatina	COV = 37 g/L
Calafetador Santa Luzia Caulk Calafeteador	COV = 82 g/L
Massa Premium Santa Luzia Caulk Santa Luzia Masilla Santa Luzia	COV = 0,88 g/L

Low VOC

We understand that healthy materials contribute to life quality of environments occupants. Our profiles have been tested and approved according to the California Department of Public Health (CDPH), standard V1.1 (2010). For that reason, they contribute to score in LEED projects in the category of Indoor Environmental Quality.

Bajo VOC

Entendemos que los materiales sustentables contribuyen a la calidad de vida de los ocupantes del entorno. Nuestros perfiles han sido probados y aprobados de acuerdo con el Departamento de Salud Pública de California (CDPH), estándar V1.1 (2010). Por esa razón, contribuyen a obtener puntajes en proyectos LEED en la categoría de Calidad Ambiental Interior.



Construções Sustentáveis

Nossa linha de perfis de poliestireno contribui para a pontuação na Certificação LEED V4, nas categorias de Materiais e Recursos, Qualidade do Ambiente Interno, Materiais Regionais e Inovação.

SUSTAINABLE CONSTRUCTIONS

Our line of polystyrene profiles contributes to the LEED V4 Certification Scoring in the categories of: Materials and Resources, Indoor Environmental Quality, Regional Materials and Innovation.

CONSTRUCCIONES SUSTENTABLES

Nuestra línea de perfiles de poliestireno contribuye al puntaje de certificación LEED V4 en las categorías de: Materiales y Recursos, Calidad Ambiental Interior, Materiales Regionales e Innovación.

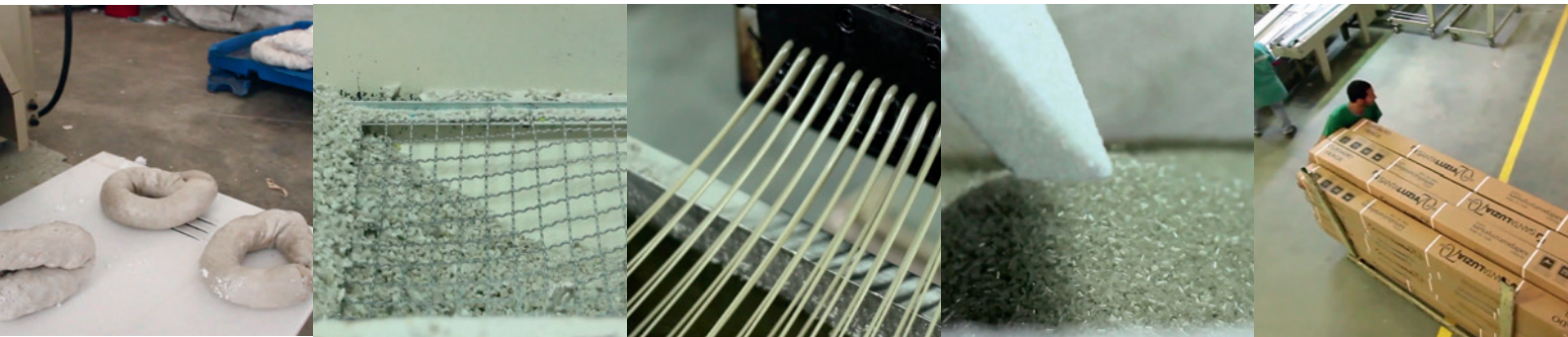

Economia Circular

Ao lado de outras grandes empresas líderes em pensamento global, a Santa Luzia amplia suas ambições para contribuir com a transição para a economia circular através do seu modelo de negócio com foco em reutilização de materiais.



1 - Refinaria

Refinery/Refineria

2 - Petroquímica

Petrochemicals/Petroquímicos

3 - Indústria de Transformação

Manufacturing Industry/Industria Manufacturera

4 - Indústria Consumidora

Consumer Industry/Industria del Consumidor

5 - Consumidor final

Final consumer/Consumidor final

6 - Coleta Seletiva

Selective Collection/Colección selectiva

7 - Cooperativas

Cooperatives/ Cooperativas

8 - Santa Luzia

Circular Economy

Alongside other leading companies in global thinking, Santa Luzia extends its ambitions to contribute to the transition for a circular economy through its business model focused on material reuse.

Economía Circular

Junto con otras empresas líderes en pensamiento global, Santa Luzia amplía sus ambiciones de contribuir a la transición hacia una economía circular a través de su modelo de negocios enfocado en la reutilización de materiales.



EPD

Nossa Declaração Ambiental de Produto (Environmental Product Declaration) demonstra de forma clara e transparente os impactos ambientais relacionados ao produto em cada etapa do seu ciclo de vida. Por meio dessa ferramenta, os fabricantes permitem que os clientes ou especificadores estejam aptos a decidir pela compra de um ou outro produto com base nessas informações. Uma importante ferramenta que vem sendo difundida no Brasil, a EPD ou DAP fornece informações relevantes com base na Avaliação de Ciclo de Vida.

EPD - Our Environmental Product Declaration clearly and transparently demonstrates the environmental impacts related to the product at each stage of its life cycle. Through this tool, manufacturers allow customers or specifiers to decide to purchase one or another product based on this information. An important tool that is being disseminated in Brazil, the EPD provides relevant information based on the Life Cycle Assessment.

EPD - Nuestra Declaración Ambiental de Producto (Environmental Product Declaration) demuestra clara y transparentemente los impactos ambientales relacionados con el producto en cada etapa de su ciclo de vida. A través de esta herramienta, los fabricantes permiten que los clientes o los especificadores decidan comprar uno u otro producto en base a esta información. Una herramienta importante que se está diseminando en Brasil, el EPD proporciona información relevante basada en la evaluación del ciclo de vida.

Sociedade



Por meio de participação em projetos de educação ambiental de algumas empresas parceiras, várias crianças recebem o programa de conscientização sobre a importância da preservação do meio ambiente e da correta destinação dos resíduos gerados por eles.

Society

Through participation in environmental education projects of some partner companies, several children receive the awareness program about the importance of preserving the environment and the correct destination of the waste generated by them.

Sociedad

A través de la participación en proyectos de educación ambiental de algunas empresas asociadas, varios niños reciben el programa de concientización sobre la importancia de preservar el medio ambiente y el destino correcto de los desechos generados por ellos.

Produto | Product | Producto

① 464 RP/BR

② 444 RP/BR

③ 466 RM/BR



Discrição pode dar um novo ar ao ambiente. A sua residência ou seu escritório, vai ganhar um toque de charme e elegância com os produtos da linha moderna.

Discretion can give a new look to the ambient. Your residence or office will have a touch of charm and elegance with the products of this line.

La discreción puede dar una nueva imagen al ambiente. Su casa o su oficina van a ganar un toque de encanto y elegancia con los productos de esta línea.

Rodapés | Skirting Boards | Zócalos

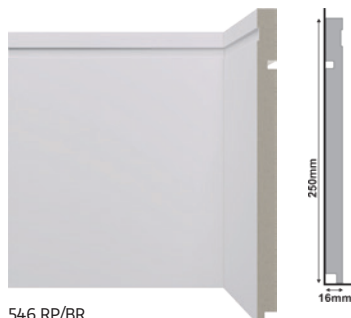

546 RP/BR
Skirting Board White | Zócalo Blanco
Cód. | Code - 27857



505 RP/BR
Skirting Board White | Zócalo Blanco
Cód. | Code - 25954



506 RP/BR
Skirting Board White | Zócalo Blanco
Cód. | Code - 25955

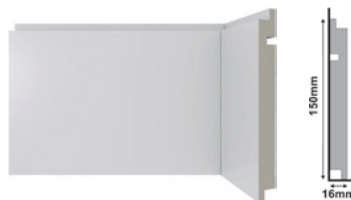

461 RP/BR
Skirting Board White | Zócalo Blanco
Cód. | Code - 20247



480 RP/BR
Skirting Board White | Zócalo Blanco
Cód. | Code - 20299

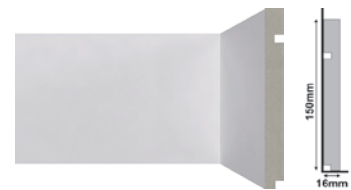

496 RP/BR
Skirting Board White | Zócalo Blanco
Cód. | Code - 24899



502 RP/BR
Skirting Board White | Zócalo Blanco
Cód. | Code - 25426

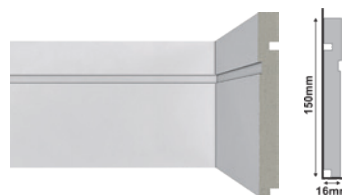

503 RP/BR
Skirting Board White | Zócalo Blanco
Cód. | Code - 25427



513 RP/BR
Skirting Board White | Zócalo Blanco
Cód. | Code - 26674



515 RP/BR
Skirting Board White | Zócalo Blanco
Cód. | Code - 26675



493 RP/BR
Skirting Board White | Zócalo Blanco
Cód. | Code - 24574



454 RP/BR
Skirting Board White | Zócalo Blanco
Cód. | Code - 20232

Rodapés | Skirting Boards | Zócalos



457 RP/BR
Skirting Board White | Zócalo Blanco
Cód. | Code - 20239



460 RP/BR
Skirting Board White | Zócalo Blanco
Cód. | Code - 20245



464 RP/BR
Skirting Board White | Zócalo Blanco
Cód. | Code - 20252



512 RP/BR
Skirting Board White | Zócalo Blanco
Cód. | Code - 26657



514 RP/BR
Skirting Board White | Zócalo Blanco
Cód. | Code - 26656



547 RP/BR
Skirting Board White | Zócalo Blanco
Cód. | Code - 27858



550 RP/BR
Skirting Board White | Zócalo Blanco
Cód. | Code - 27860



565 RP/BR
Skirting Board White | Zócalo Blanco
Cód. | Code - 28751



446 RP/BR
Skirting Board White | Zócalo Blanco
Cód. | Code - 20013



451 RP/BR
Skirting Board White | Zócalo Blanco
Cód. | Code - 20229



456 RP/BR
Skirting Board White | Zócalo Blanco
Cód. | Code - 20237



459 RP/BR
Skirting Board White | Zócalo Blanco
Cód. | Code - 20243



441 RP/BR
Skirting Board White | Zócalo Blanco
Cód. | Code - 20003



455 RP/BR
Skirting Board White | Zócalo Blanco
Cód. | Code - 20234



466 RP/BR
Skirting Board White | Zócalo Blanco
Cód. | Code - 20255



473 RP/BR
Skirting Board White | Zócalo Blanco
Cód. | Code - 24545



478 RP/BR
Skirting Board White | Zócalo Blanco
Cód. | Code - 20297

Utilize Santa Luzia
Massa Premium
na cor BRANCA para um
acabamento perfeito.
Use Santa Luzia WHITE premium caulk
for a perfect finish.
Utilice Santa Luzia masilla BLANCA
premium para un acabado perfecto.



Guarniões | Door Casings | Contramarcos

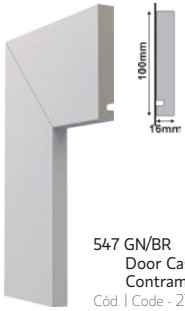

547 GN/BR
Door Case White
Contramarco Blanco
Cód. | Code - 27859

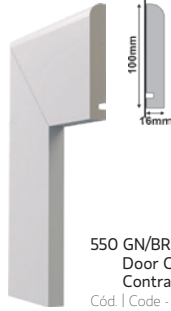

550 GN/BR
Door Case White
Contramarco Blanco
Cód. | Code - 27861

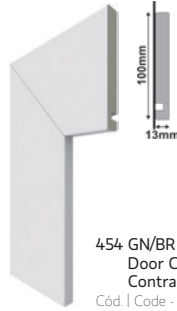

454 GN/BR
Door Case White
Contramarco Blanco
Cód. | Code - 20233

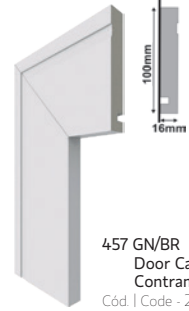

457 GN/BR
Door Case White
Contramarco Blanco
Cód. | Code - 20240

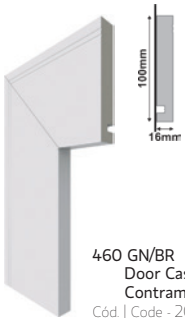

460 GN/BR
Door Case White
Contramarco Blanco
Cód. | Code - 20246



512 GN/BR
Door Case White
Contramarco Blanco
Cód. | Code - 26678

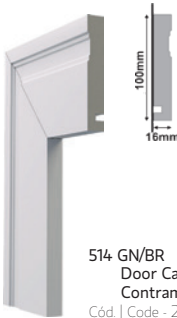

514 GN/BR
Door Case White
Contramarco Blanco
Cód. | Code - 26679

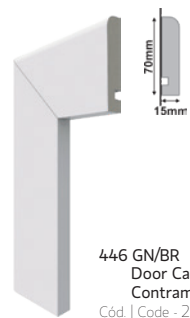

446 GN/BR
Door Case White
Contramarco Blanco
Cód. | Code - 20021

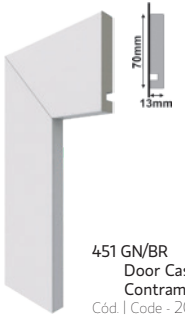

451 GN/BR
Door Case White
Contramarco Blanco
Cód. | Code - 20230



456 GN/BR
Door Case White
Contramarco Blanco
Cód. | Code - 20238

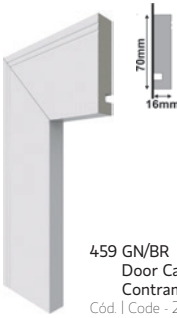

459 GN/BR
Door Case White
Contramarco Blanco
Cód. | Code - 20244

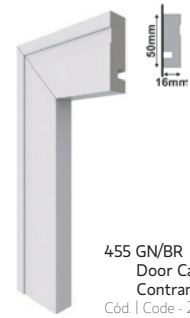

455 GN/BR
Door Case White
Contramarco Blanco
Cód. | Code - 20236

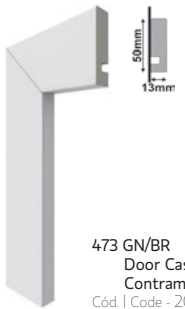

473 GN/BR
Door Case White
Contramarco Blanco
Cód. | Code - 20398

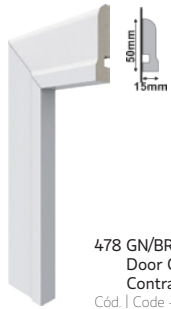

478 GN/BR
Door Case White
Contramarco Blanco
Cód. | Code - 20298

Regulável | Adjustable | Ajustable

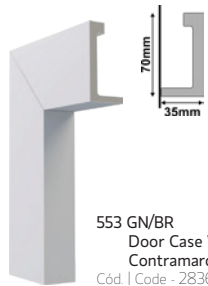

553 GN/BR
Door Case White - Adjustable
Contramarco Blanco - Ajustable
Cód. | Code - 28369

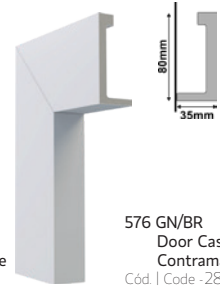

576 GN/BR
Door Case White - Adjustable
Contramarco Blanco - Ajustable
Cód. | Code - 28369

Rodameio
Chair Rail | Guardasilla



466 RW/BR
Trim White | Guardasilla Blanco
Cód. | Code - 20256

Rodatetos | Crown Mouldings | Cornisas



457 RT/BR
Crown White | Cornisa Blanco
Cód. | Code - 25787



441 RT/BR
Crown White | Cornisa Blanco
Cód. | Code - 25785

Produtos | Products | Productos

- ① 465 RM/BR
- ② 475 RT/BR
- ③ 443 RP/BR

Linha Clássica

Classic Line | Línea Clásica

PRODUTO
SANTALUZIA

Barras de 2,40m | 8ft bars

Opção ideal para quem faz questão de requinte e sofisticação. Com a Linha Clássica, você nunca vai ficar fora da moda.

Ideal option for those who value refinement and sophistication. With the classic line, you will never go out of style.

Opción ideal para quien quiere un punto de refinamiento y sofisticación. Con la línea clásica usted nunca estará fuera de moda.

Rodapés | Skirting Boards | Zócalos



01 RP/BR
Skirting Board White | Zócalo Blanco
Cód. | Code - 20001



443 RP/BR
Skirting Board White | Zócalo Blanco
Cód. | Code - 20007



444 RP/BR
Skirting Board White | Zócalo Blanco
Cód. | Code - 20009



442 RP/BR
Skirting Board White | Zócalo Blanco
Cód. | Code - 20005

Rodatetos | Crown Moulding | Cornisas



01 RT/BR
Crown White | Cornisa Blanco
Cód. | Code - 25784



444 RT/BR
Crown White | Cornisa Blanco
Cód. | Code - 25786



475 RT/BR
Crown White | Cornisa Blanco
Cód. | Code - 20294

Rodameios | Chair Rails | Guardasillas



467 RM/BR
Trim White | Guardasilla Blanco
Cód. | Code - 20292



465 RM/BR
Trim White | Guardasilla Blanco
Cód. | Code - 20254



448 RM/BR
Trim White | Guardasilla Blanco
Cód. | Code - 20227

Guarniões | Door Casings | Contramarcos

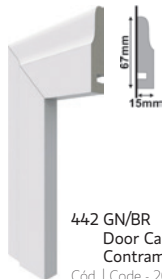

442 GN/BR
Door Case White
Contramarco Blanco
Cód. | Code - 20006

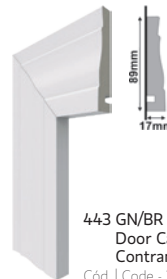

443 GN/BR
Door Case White
Contramarco Blanco
Cód. | Code - 20008

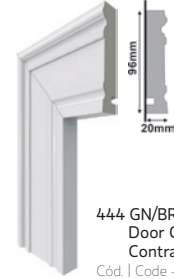

444 GN/BR
Door Case White
Contramarco Blanco
Cód. | Code - 20010

Sócalos e Rosetas | Plinth Blocks and Rosettes | Sócalins y Rosetas

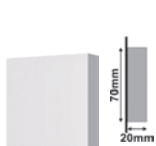

Roseta 175 | Rosette | Roseta
70 x 70 x 20mm
Cód. | Code - 27380

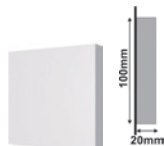

Roseta 176 | Rosette | Roseta
100 x 100 x 20mm
Cód. | Code - 27375

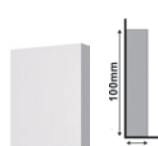

Sócalo 177
Plinth Block | Zócalin
80 x 100 x 20mm
Cód. | Code - 27367

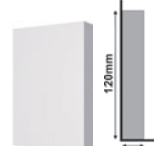

Sócalo 178
Plinth Block | Zócalin
80 x 120 x 20mm
Cód. | Code - 27368



Sócalo 183
Plinth Block | Zócalin
70 x 150 x 20mm
Cód. | Code - 27373

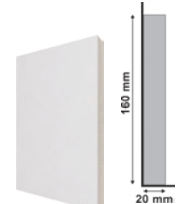

Sócalo 187
Plinth Block | Zócalin
110 x 160 x 20mm
Cód. | Code - 27377



Sócalo 186
Plinth Block | Zócalin
80 x 160 x 20mm
Cód. | Code - 27376



Sócalo 179
Plinth Block | Zócalin
80 x 220 x 20mm
Cód. | Code - 27369

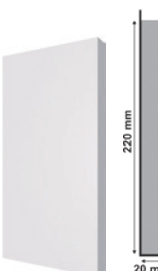

Sócalo 181
Plinth Block | Zócalin
110 x 220 x 20mm
Cód. | Code - 27371



Sócalo 180
Plinth Block | Zócalin
110 x 240 x 20mm
Cód. | Code - 27370



Sócalo 182
Plinth Block | Zócalin
110 x 270 x 20mm
Cód. | Code - 27372

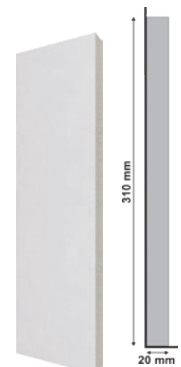

Sócalo 188
Plinth Block | Zócalin
110 x 310 x 20mm
Cód. | Code - 27378

Meia Curva | Half Round | Media Caña

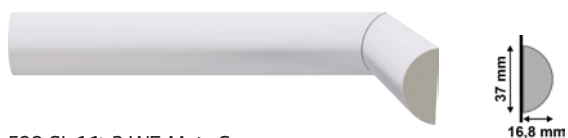

599 SL 11t-2 WE Meia Curva
599 SL 11-2 WE Half Round | 599 SL 11-2 WE Media Caña
Code: 22553



597 SL 5-8 WE Meia Curva
597 SL 5-8 WE Half Round | 597 SL 5-8 WE Media Caña
Code: 22554



598 SL 1 WE Meia Curva
598 SL 1 WE Half Round | 598 SL 1 WE Media Caña
Code: 22555

Acabamento de rodapé Quarter Round | Molduras de Sobreponer



468 SL 11-16 WE Acabamento para Rodapé
468 SL 11-16 WE Quarter Round | 468 SL 11-16 WE Molduras de sobreponer
Code: 22558



605 SL 13-16 WE Acabamento para Rodapé
605 SL 13-16 WE Baseboard | 605 SL 13-16 WE Molduras de sobreponer
Code: 22560

Cantoneiras Corner Guard | Esquineiro em L



604 SL 11-4 WE Cantoneira
604 SL 11-4 WE CornerGuard | 604 SL 11-4 WE Esquineiro em L
Code: 22556



603 SL 5-8 WE Cantoneira
603 SL 5-8 WE CornerGuard | 603 SL 5-8 WE Esquineiro em L
Code: 22557

Arredondado Quarter Round | Cuarta Caña

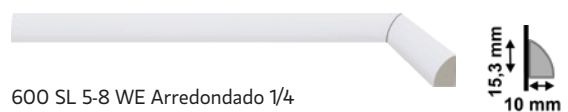

600 SL 5-8 WE Arredondado 1/4
600 SL 5-8 WE Quarter Round | 600 SL 5-8 WE Cuarta Caña
Code: 22561

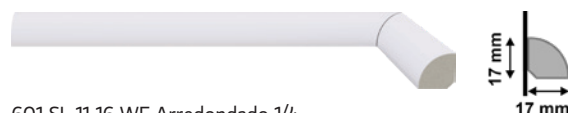

601 SL 11-16 WE Arredondado 1/4
601 SL 11-16 WE Quarter Round | 601 SL 11-16 WE Cuarta Caña
Code: 22562

Borda arredondada Round Edge | Tapajunta

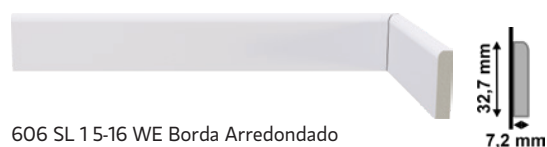

606 SL 15-16 WE Borda Arredondado
606 SL 15-16 WE Round Edge | 606 SL 15-16 WE Tapajunta
Code: 22563

Meia Cana | Cove | Rinconero



602 SL 5-8 WE Meia Cana
602 SL 5-8 WE Cove | 602 SL 5-8 WE Rinconero
Code: 22564

Produtos | Products | Productos

① 448 RM/BR

①



Produtos | Products | Productos

① KIT Guarnição 456

①



Kit Guarnição

PRODUTO
SANTALUZIA

Casing Pro Pack | Kit Contramarco

02 Barras de 2,20m e 01 barra de 1,10m | 02 bars of 2,20m and 01 bar of 1,10m

O Kit Guarnição da Indústria Santa Luzia foi desenvolvido para diminuir a geração de resíduos com guarnições ao criar molduras em portas/portais de ambientes internos. Evitando o desperdício, o Kit fornece dois perfis para laterais e um para o topo, cortados e acabados nas medidas de diferentes padrões de portas, de modo que você possa se concentrar somente na instalação!

Santa Luzia's Casing Pro Pack was developed to reduce the waste of our casings by creating frames on indoor doors/portals. Avoiding waste, the Kit provides two profiles for the lateral sides of the door and one for the top, cut and finished to the dimensions of different door patterns, so that you can concentrate only on the installation!

El kit contramarco de la Industria de Santa Luzia se desarrolló para reducir la generación de desechos con recortes mediante la creación de marcos en puertas/portales para ambientes interiores. Evitando desperdicios, el Kit proporciona dos perfiles para los lados y uno para la parte superior, cortados y acabados a las dimensiones de diferentes patrones de puertas, para que pueda concentrarse solo en la instalación!

Produtos | Products | Productos

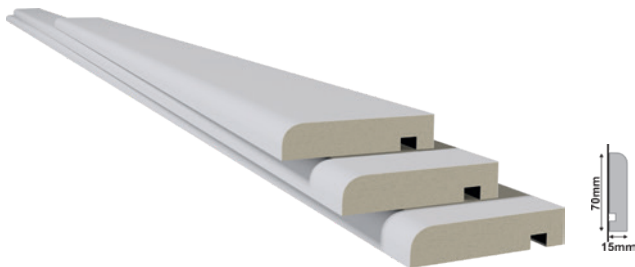

Kit Guarnição 446 Branco
Door Case Pro Pack 446 White | Kit Contramarco 446 Blanco
Cód. | Code - 20335



Kit Guarnição 446 Natural 04
Door Case Pro Pack 446 Natural 04 | Kit Contramarco Natural 04
Cód. | Code - 28906



Kit Guarnição 456 Branco
Door Case Pro Pack 456 White | Kit Contramarco 456 Blanco
Cód. | Code - 20681



Kit Guarnição 455 Branco
Door Case Pro Pack 455 White | Kit Contramarco 455 Blanco
Cód. | Code - 20680

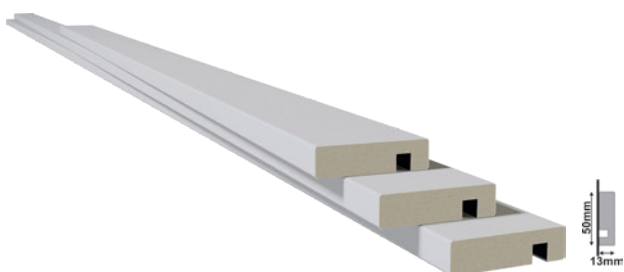

Kit Guarnição 473 Branco
Door Case Pro Pack 473 White | Kit Contramarco 473 Blanco
Cód. | Code - 28904

Utilize Santa Luzia
Massa Premium
para um acabamento
perfeito.

Use Santa Luzia premium caulk for a
perfect finish.

Utilice Santa Luzia masilla premium
para un acabado perfecto.



TODOS OS KITS ACOMPANHAM:

Todos os Kits acompanham: / All the Pro Packs come along with:

- 02 barras de 2,20 m e 01 barra de 1,10 m
- 14 buchas e 14 pregos
- Gabarito para marcação de 5 cm

- 02 bars of 2,20 m and 01 bar of 1,10 m
- 14 brackets and 14 nails
- Mounting model for 2" marking

- 02 barras de 2,20 m y 01 barra de 1,10 m
- 14 tarugos y 14 clavos
- Plantilla de montaje para marcado de 5 cm

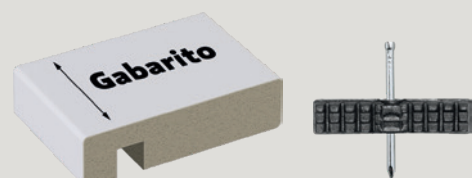



1

2

Produtos | Products | Productos

① 467 RM/BR

② 448 RM/BR

Coleção Boiseries

PRODUTO
SANTALUZIA

Wall Paneling Collection | Colección Boiseries

Esta coleção traz peças únicas pré-fabricados, que podem ser utilizadas para criar painéis de parede para boiserie, adicionando elegância e beleza em qualquer ambiente

This collection brings finished single pieces, wich can be used to create wall panels for Wall paneling/Boiseries, adding elegance and beauty in any rooms.

Esta colección trae piezas únicas prefabricadas, que se pueden utilizar para crear paneles de pared para boiserie, añadiendo elegancia y belleza en cualquier ambiente.

Produtos | Products | Productos



Boiserie | Wall Paneling
Cód. | Code - 28691



Boiserie | Wall Paneling
Cód. | Code - 28692



Boiserie | Wall Paneling
Cód. | Code - 28693



Boiserie | Wall Paneling
Cód. | Code - 28694



Rápido e prático de aplicar DIY - Faça você mesmo

*Quick and easy to apply - DIY - Do it yourself
DIY - Hágalo usted mismo - Rápido y práctico de instalar*

Fita dupla face em todo o verso

*Comes with Double sided tape on back of product
Incluye cinta doble cara en la parte posterior de lo producto*

Com nível para ajuste rápido

*Comes with level for perfect and quick setting
Incluye nivel para un ajuste perfecto y rápido*

Roseta
Rosette | Roseta

Guarnição
Door Case
Contramarco

Boiserie
Wall Paneling
Recuadros de Enmarcado
90cm x 60cm

Boiserie
Wall Paneling
Recuadros de Enmarcado
70cm x 60cm

Sócalo
Plinth Block | Zocalín

Rodapé
Baseboard | Zócalo



Porta: 2,10m x 0,80m
Based on door size: 2,10m x 0,80m
Puerta: 2,10m x 0,80m

Utilize Santa Luzia
Massa Premium
na cor BRANCA para um
acabamento perfeito.

Use Santa Luzia **WHITE** premium caulk
for a perfect finish.
Utilice Santa Luzia masilla **BLANCA**
premium para un acabado perfecto.



Produtos | Products | Productos

① Sócalo 204

② 544 RP/BR

③ 543 GN/BR

③

②

①

Inspirada no movimento Art Déco iniciado na França há mais de 90 anos, a coleção traz traços firmes e formatos geométricos para quem gosta de estilo com sobriedade, ordem e simetria.

This collection brings firm collection and geometric shapes to those who like style with sobriety, order and symmetry.

La colección trae trazos firmes y formatos geométricos para quienes gustan de estilo con sobriedad, orden y simetría.

Produtos | Products | Productos



544 RP/BR
Skirting Board White | Zócalo Blanco
Cód. | Code - 27854



542 RW/BR
Trim White | Guardasilla Blanco
Cód. | Code - 27853



545 RT/BR
Crown White | Cornisa Blanco
Cód. | Code - 27855



543 GN/BR
Door Case White
Contramarco Blanco
Cód. | Code - 27852

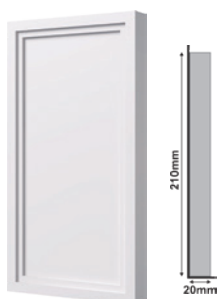

Sócalo 204 | Plinth Block | Zocalin
110 x 210 x 20mm
Cód. | Code - 27868



Roseta 203 | Rossete | Roseta
100 x 100 x 20mm
Cód. | Code - 27867

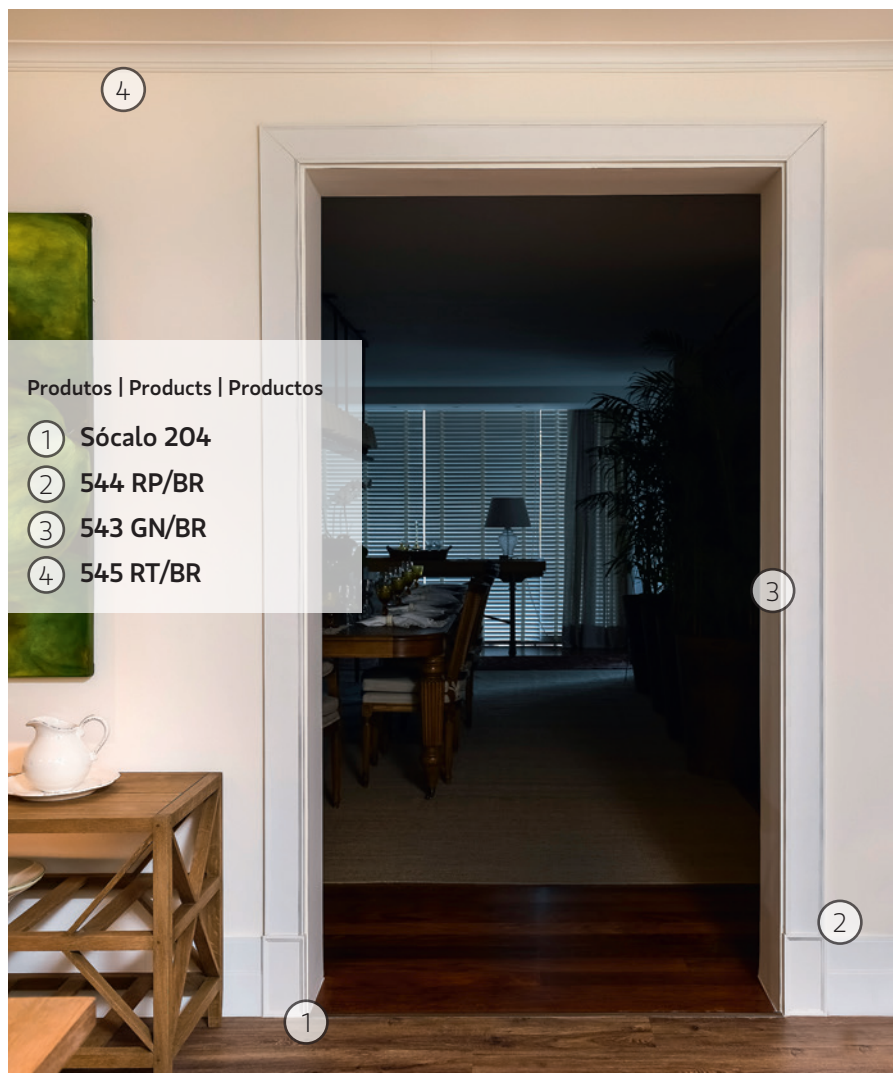

Arq. Mariela Klann Fonteyne - Foto: Miro Martins



Utilize Santa Luzia
Massa Premium
na cor BRANCA para um
acabamento perfeito.

Use Santa Luzia WHITE premium caulk
for a perfect finish.
Utilice Santa Luzia masilla BLANCA
premium para un acabado perfecto.



Produto | Product | Producto

① 523 RP/BR

①

Uma composição entre detalhes e desenhos que se diferenciam em um jogo de contrastes e harmonias.

A composition of details and designs that differ in a game of contrasts and harmonies in which the pieces fit together in unusual ways.

Una composición de detalles y diseños que difieren en un juego de contrastes y armonías donde las piezas se acoplan de manera inusual.

Rodapés | Skirting Board | Zócalos

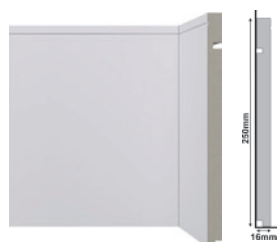

520 RP/BR
Skirting Board White | Zócalo Blanco
Cód. | Code - 27080



519 RP/BR
Skirting Board White | Zócalo Blanco
Cód. | Code - 27079



518 RP/BR
Skirting Board White | Zócalo Blanco
Cód. | Code - 27078

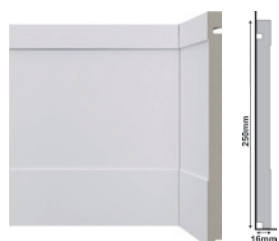

524 RP/BR
Skirting Board White | Zócalo Blanco
Cód. | Code - 27084



523 RP/BR
Skirting Board White | Zócalo Blanco
Cód. | Code - 27083



522 RP/BR
Skirting Board White | Zócalo Blanco
Cód. | Code - 27082

Guarnições

Casings | Contramarcos



517 GN/BR
Door Case White
Contramarco Blanco
Cód. | Code - 27077



521 GN/BR
Door Case White
Contramarco Blanco
Cód. | Code - 27081

Sócalos e Rosetas | Plinth Blocks and Rosettes | Zócalins y Rosetas



Sócalo 196 | Plinth Block | Zócalin
110 x 260 x 20mm
Cód. | Code - 27024



Sócalo 195 | Plinth Block | Zócalin
110 x 210 x 20mm
Cód. | Code - 27023



Sócalo 194 | Plinth Block | Zócalin
110 x 160 x 20mm
Cód. | Code - 27022



Roseta 193
Rosette | Roseta
100 x 100 x 20mm
Cód. | Code - 27021

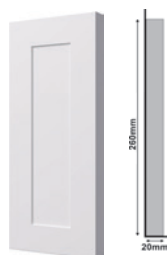

Sócalo 200 | Plinth Block | Zócalin
110 x 260 x 20mm
Cód. | Code - 27028



Sócalo 199 | Plinth Block | Zócalin
110 x 210 x 20mm
Cód. | Code - 27027



Sócalo 198 | Plinth Block | Zócalin
110 x 160 x 20mm
Cód. | Code - 27026



Roseta 197
Rosette | Roseta
100 x 100 x 20mm
Cód. | Code - 27025



Utilize Santa Luzia
Massa Premium
na cor BRANCA para um
acabamento perfeito.

Use Santa Luzia WHITE premium caulk
for a perfect finish.
Utilice Santa Luzia masilla BLANCA
premium para un acabado perfecto.

Produtos | Products | Productos

- ① 518 RP/Cinza Glacial
- ② 517 GN/Cinza Glacial
- ③ 194 Sócalo/Cinza Glacial

Duas cores exclusivas formam a Coleção Inova Uber, permitindo maior customização, elegância e aconchego a diversos ambientes.

Two unique colors create the Inova Collection Uber, allowing greater customization, elegance and warmth to diverse environments.

Dos colores exclusivos forman la Colección Inova Uber, lo que permite una mayor personalización, elegancia y comodidad a diversos ambientes.

Rodapés | Skirting Boards | Zócalos

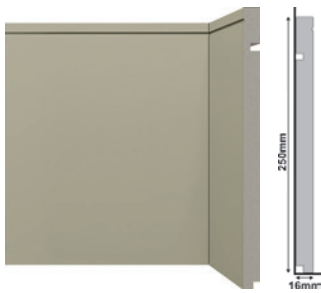

520 RP/Cinza Glacial
Skirting Board Glacial Gray
Zócalo Gris Glacial
Cód. | Code - 27532

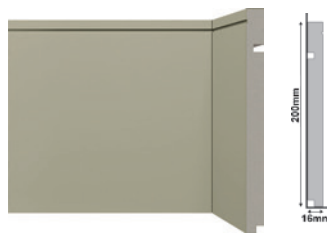

519 RP/Cinza Glacial
Skirting Board Glacial Gray
Zócalo Gris Glacial
Cód. | Code - 27531



518 RP/Cinza Glacial
Skirting Board Glacial Gray
Zócalo Gris Glacial
Cód. | Code - 27530

Sócalos e Rosetas | Plinth Blocks and Rosettes | Zócalins y Rosetas

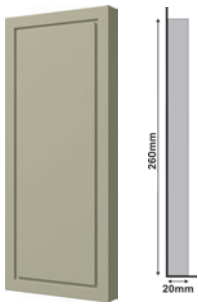

Sócalo 196 Cinza Glacial
Plinth Block Glacial Gray
Zócalin Gris Glacial
110 x 260 x 20mm
Cód. | Code - 27536

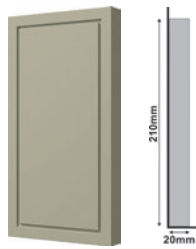

Sócalo 195 Cinza Glacial
Plinth Block Glacial Gray
Zócalin Gris Glacial
110 x 210 x 20mm
Cód. | Code - 27535

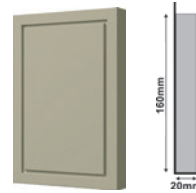

Sócalo 194 Cinza Glacial
Plinth Block Glacial Gray
Zócalin Gris Glacial
110 x 160 x 20mm
Cód. | Code - 27534

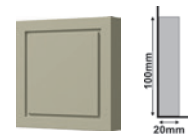

Roseta 193 Cinza Glacial
Rosette Glacial Gray
Roseta Gris Glacial
100 x 100 x 20mm
Cód. | Code - 27533

Guarniões | Casings | Contramarcos

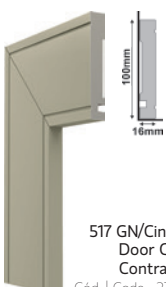

517 GN/Cinza Glacial
Door Case Glacial Gray
Contramarco Gris Glacial
Cód. | Code - 27529

Utilize Santa Luzia Massa Premium nas cores do produto.

Use Santa Luzia premium caulk in product colors.
Utilice Santa Luzia masilla premium en los colores del producto.



Rodapés | Skirting Boards | Zócalos

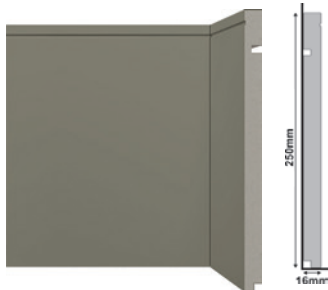

520 RP/Cinza Titanium
Skirting Board Titanium Gray
Zócalo Gris Titano
Cód. | Code - 27524



519 RP/Cinza Titanium
Skirting Board Titanium Gray
Zócalo Gris Titano
Cód. | Code - 27523



518 RP/Cinza Titanium
Skirting Board Titanium Gray
Zócalo Gris Titano
Cód. | Code - 27522

Sócalos e Rosetas | Plinth Blocks and Rosettes | Zócalins y Rosetas

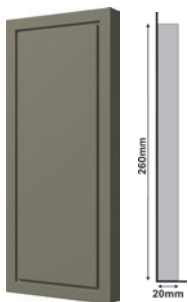

Sócalo 196 Cinza Titanium
Plinth Block Titanium Gray
Zócalin Gris Titano
110 x 260 x 20mm
Cód. | Code - 27528

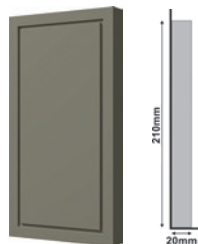

Sócalo 195 Cinza Titanium
Plinth Block Titanium Gray
Zócalin Gris Titano
110 x 210 x 20mm
Cód. | Code - 27527



Sócalo 194 Cinza Titanium
Plinth Block Titanium Gray
Zócalin Gris Titano
110 x 160 x 20mm
Cód. | Code - 27526

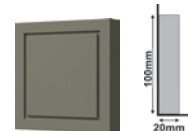

Roseta 193 Cinza Titanium
Rosette Titanium Gray
Roseta Gris Titano
100 x 100 x 20mm
Cód. | Code - 27525

Guarniões | Casings | Contramarcos

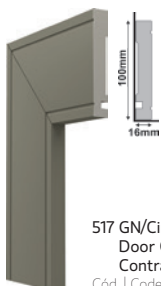

517 GN/Cinza Titanium
Door Case Titanium Gray
Contramarco Gris Titano
Cód. | Code - 27521



Utilize Santa Luzia Massa Premium nas cores do produto.

Use Santa Luzia premium caulk in product colors.
Utilice Santa Luzia masilla premium en los colores del producto.



Produtos | Products | Productos

① 520 RP/Cinza Titanium



DANIELA COLNAGHI

①

1

Produto | Product | Producto

① 496 RP/Cinza Titanium

Coleção **POP DECOR**



Pop Decor Collection | Colección Pop Decor

Barras de 2,40m | 240 cm bars

Unindo o mix de perfis da Santa Luzia mais procurados nas revendas às nuances do cinza, a Pop Decor é a solução ideal para decorações contemporâneas de paleta neutra, complementando-se suavemente nas tonalidades Titanium e Glacial a móveis, pinturas e outros acabamentos. A linha reúne, entre modelos de superfície lisa e frisada, seis opções de rodapé, quatro de guarnição, três sócalos e duas rosetas.

Combining the mix of Santa Luzia's most sought out profiles at retailers with the nuances of gray, Pop Decor is the ideal solution for contemporary neutral palette decoration. The line brings together, smooth and beaded surface models, six baseboard options, four casings, three plinth blocks and two rosettes.

Uniendo la mezcla más codiciada de los perfiles de Santa Luzia en las reventas con los matices del gris, Pop Decor es la solución ideal para decoraciones de paletas neutras contemporáneas, complementándose suavemente en tonos titanio y glacial con muebles, pinturas y otros Acabados. La línea reúne, entre modelos de superficie lisa y con cuentas, seis opciones de zócalos, cuatro de guarniciones, tres socallines y dos rosetas.

Guarnições | Casings | Contramarcos

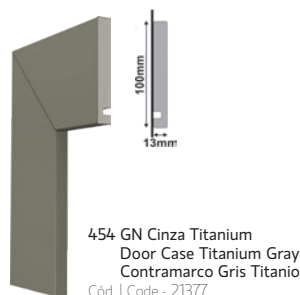
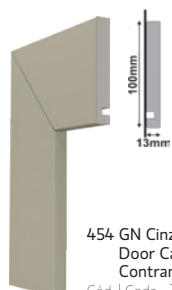

A Coleção Pop Decor oferece Terminais de Acabamento sob Encomenda. Veja todos os modelos em acessórios (página 62).

The Pop Decor Collection offers customized Finishing Corners. See all in accessories (page 62).

La colección Pop Decor ofrece Guardias de Topo hechos a pedido. Vea todos en accesorios (p. 62).

Rodapés | Skirting Boards | Zócalos

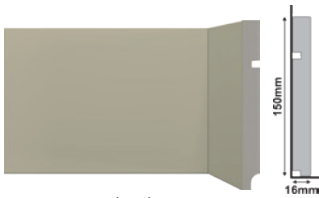

496 RP Cinza Glacial
Skirting Board Glacial Gray
Zócalo Gris Glacial

Cód. | Code - 21380



454 RP Cinza Glacial
Skirting Board Glacial Gray
Zócalo Gris Glacial

Cód. | Code - 21375



451 RP Cinza Glacial
Skirting Board Glacial Gray
Zócalo Gris Glacial

Cód. | Code - 21367

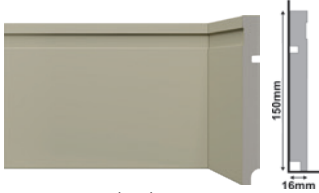

480 RP Cinza Glacial
Skirting Board Glacial Gray
Zócalo Gris Glacial

Cód. | Code - 29869

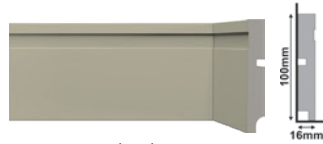

457 RP Cinza Glacial
Skirting Board Glacial Gray
Zócalo Gris Glacial

Cód. | Code - 29867



456 RP Cinza Glacial
Skirting Board Glacial Gray
Zócalo Gris Glacial

Cód. | Code - 21371

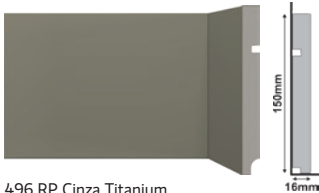

496 RP Cinza Titanium
Skirting Board Titanium Gray
Zócalo Gris Titanio

Cód. | Code - 21381



454 RP Cinza Titanium
Skirting Board Titanium Gray
Zócalo Gris Titanio

Cód. | Code - 28730

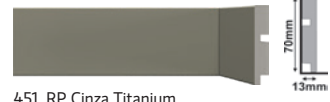

451 RP Cinza Titanium
Skirting Board Titanium Gray
Zócalo Gris Titanio

Cód. | Code - 21369

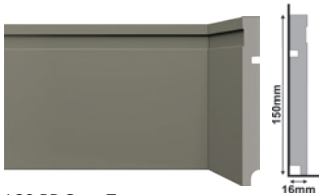

480 RP Cinza Titanium
Skirting Board Titanium Gray
Zócalo Gris Titanio

Cód. | Code - 29870

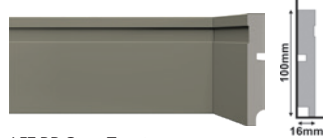

457 RP Cinza Titanium
Skirting Board Titanium Gray
Zócalo Gris Titanio

Cód. | Code - 29868



456 RP Cinza Titanium
Skirting Board Titanium Gray
Zócalo Gris Titanio

Cód. | Code - 21373

Sócalos e Rosetas | Plinth Blocks and Rosettes | Zócalins y Rosetas

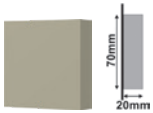

Roseta 175 Cinza Glacial
Rosette Glacial Gray
Roseta Gris Glacial

70 x 70 x 20mm

Cód. | Code - 21382

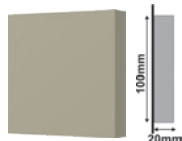

Roseta 176 Cinza Glacial
Rosette Glacial Gray
Roseta Gris Glacial

100 x 100 x 20mm

Cód. | Code - 21384

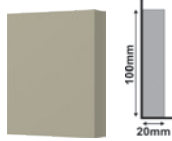

Sócalo 177 Cinza Glacial
PLinth Block Glacial Gray
Zócalin Gris Glacial

80 x 100 x 20mm

Cód. | Code - 29276

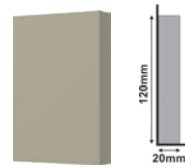

Sócalo 178 Cinza Glacial
PLinth Block Glacial Gray
Zócalin Gris Glacial

80 x 120 x 20mm

Cód. | Code - 21387

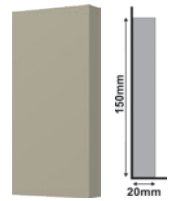

Sócalo 183 Cinza Glacial
PLinth Block Glacial Gray
Zócalin Gris Glacial

70 x 150 x 20mm

Cód. | Code - 21389

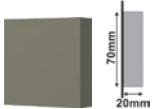

Roseta 175 Cinza Titanium
Rosette Titanium Gray
Roseta Gris Titanio

70 x 70 x 20mm

Cód. | Code - 21383

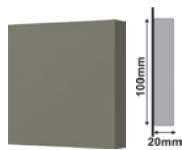

Roseta 176 Cinza Titanium
Rosette Titanium Gray
Roseta Gris Titanio

100 x 100 x 20mm

Cód. | Code - 21385

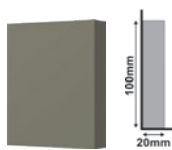

Sócalo 177 Cinza Titanium
PLinth Block Titanium Gray
Zócalin Gris Titanio

80 x 100 x 20mm

Cód. | Code - 21386

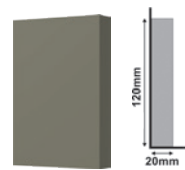

Sócalo 178 Cinza Titanium
PLinth Block Titanium Gray
Zócalin Gris Titanio

80 x 120 x 20mm

Cód. | Code - 21388

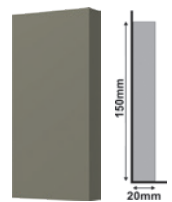

Sócalo 183 Cinza Titanium
PLinth Block Titanium Gray
Zócalin Gris Titanio

70 x 150 x 20mm

Cód. | Code - 21390

Produto | Product | Producto

① 3505 RP/Black



①

Coleção Black

HISTÓRIA, inovação e responsabilidade socioambiental.

HISTORY, innovation and socio-environmental responsibility.

HISTORIA, innovación y responsabilidad social y ambiental.

Rodapés | Skirting Boards | Zócalos



3505 RP/Black
Skirting Board Black | Zócalo Negro
Cód. | Code - 27086



3461 RP/Black
Skirting Board Black | Zócalo Negro
Cód. | Code - 26450



3480 RP/Black
Skirting Board Black | Zócalo Negro
Cód. | Code - 26449



3496 RP/Black
Skirting Board Black | Zócalo Negro
Cód. | Code - 29293



NOVO
3451 RP/Black
Skirting Board Black | Zócalo Negro
Cód. | Code - 21365



3457 RP/Black
Skirting Board Black | Zócalo Negro
Cód. | Code - 26445



3547 RP/Black
Skirting Board Black | Zócalo Negro
Cód. | Code - 29294



3444 RP/Black
Skirting Board Black | Zócalo Negro
Cód. | Code - 26448



3466 RP/Black
Skirting Board Black | Zócalo Negro
Cód. | Code - 27537

Sócalos e Rosetas | Plinth Blocks and Rosettes | Zócalins y Rosetas



3181 Sócalo Black
Plinth Block Black | Zócalin Negro
110 x 220 x 20mm
Cód. | Code - 27592



3187 Sócalo Black
Plinth Block Black | Zócalin Negro
110 x 160 x 20mm
Cód. | Code - 27593



3176 Roseta Black
Rosette Black | Roseta Negro
100 x 100 x 20mm
Cód. | Code - 27538

Guarnições | Door Casings | Contramarcos



3457 GN/Black
Door Case Black
Contramarco Negro
Cód. | Code - 26446



3547 GN/Black
Door Case Black
Contramarco Negro
Cód. | Code - 29295

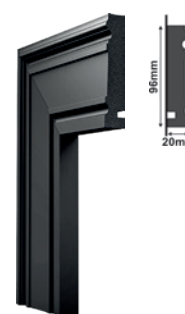

3444 GN/Black
Door Case Black
Contramarco Negro
Cód. | Code - 26447

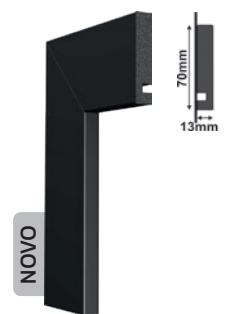

NOVO
3451 GN/Black
Door Case Black
Contramarco Negro
Cód. | Code - 21366

Rodameio | Chail Rail | Guardasilla



3466 RM/Black
Trim Black | Guardasilla Negro
Cód. | Code - 28663



3448 RM/Black
Trim Black | Guardasilla Negro
Cód. | Code - 28686

Utilize Santa Luzia
Massa Premium Preta

Use Santa Luzia in Black
premium caulk
Utilice Santa Luzia masilla
premium negro.



Produto | Product | Producto

① 3454 GN/Ouro + Filete Ouro

①

Um toque inovador que produz efeitos de pura sofisticação de prata, ouro e cobre para o contorno de ambientes mais ousados.

An innovative touch that produces effects of pure sophistication of silver, gold and copper for the outline of bolder environments.

Un toque innovador que produce efectos de sofisticación de plata, oro y cobre para el entorno de ambientes más osados.

Rodapés | Skirting Boards | Zócalos



3454 Rodapé Cobre
Skirting Board Cooper | Zócalo Cobre
Cód. | Code - 26680



3454 Rodapé Prata
Skirting Board Silver | Zócalo Plata
Cód. | Code - 26684



3454 Rodapé Ouro
Skirting Board Gold | Zócalo Oro
Cód. | Code - 26682

Guarnições | Door Casings | Contramarcos



3454 Guarnição Cobre
Door Case Cooper
Contramarco Cobre
Cód. | Code - 26681



3454 Guarnição Prata
Door Case Silver
Contramarco Plata
Cód. | Code - 26685



3454 Guarnição Ouro
Door Case Gold
Contramarco Oro
Cód. | Code - 26683



Utilize Santa Luzia Massa Premium nas cores COBRE, PRATA ou OURO para um acabamento perfeito.

Use Santa Luzia Massa in Cooper, Silver or Gold Premium caulk for a perfect finish.
Utilice Santa Luzia masilla premium en los colores Cobre, Plata o Oro para un acabado perfecto.

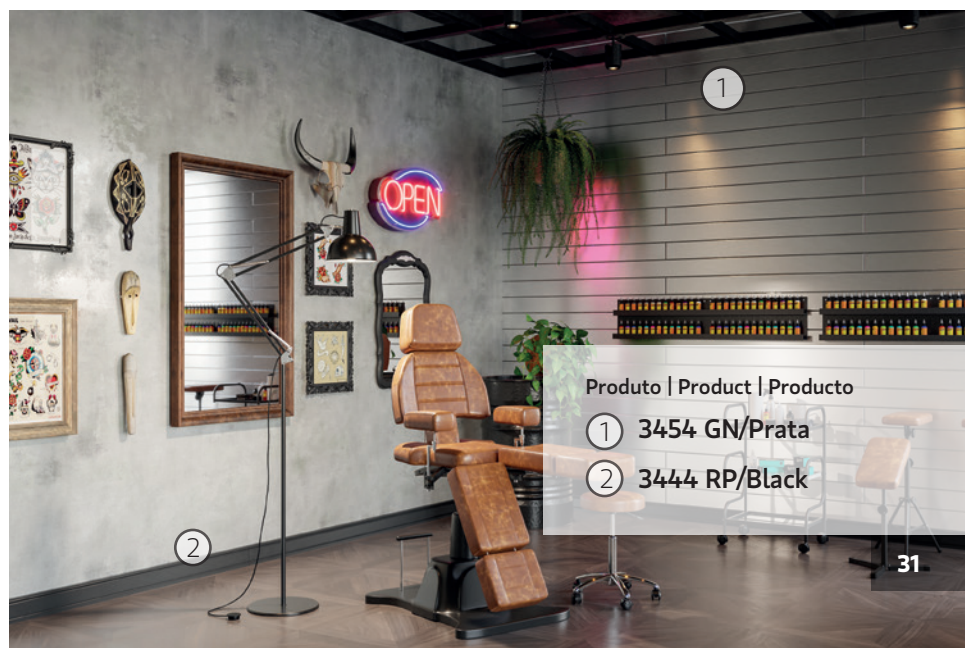



1

2

Produto | Product | Producto

① 3496 RP/OXI Ouro Rose

② 496 RP/Cinza Titanium

Com a Coleção OXI, a Santa Luzia introduz perfis de acabamentos metálicos com efeito desgastado pelo tempo, seguindo tendência de pisos e revestimentos cerâmicos. A coleção é composta de rodapés de 15 cm de altura e guarnições de 10 cm.

With the OXI collection, Santa Luzia introduces profiles of metallic finishes with a time-worn effect, following a tendency of floors and ceramic tiles. The collection is composed of 6" high baseboards and 4" casings.

Con la colección OXI, Santa Luzia introduce perfiles de acabados metálicos con un efecto desgastado por el tiempo, siguiendo una tendencia de pisos y baldosas cerámicas. La colección está compuesta de zócalos de 15 cm de alto y contramarcos de 10 cm.

Rodapés | Skirting Boards | Zócalos

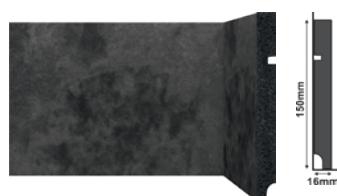

3496 RP OXI Preto
Skirting Board OXI Black | Zócalo OXI Negro
Cód. | Code - 28585



3496 RP OXI Prata
Skirting Board OXI Silver | Zócalo OXI Plata
Cód. | Code - 28586



3496 RP OXI Ouro
Skirting Board OXI Gold | Zócalo OXI Oro
Cód. | Code - 28587



3496 RP OXI Ouro Rose
Skirting Board OXI Rose Gold | Zócalo OXI Oro Rosa
Cód. | Code - 28588



Utilize Santa Luzia Massa Premium nas cores PRETA, COBRE, PRATA ou OURO para um acabamento perfeito.
Use Santa Luzia premium caulk in BLACK, COPPER, SILVER or GOLD for a perfect finish.
Utilice Santa Luzia masilla premium en NEGRO, COBRE PLATA o ORO para un acabado perfecto.

Guarnições | Door Casings | Contramarcos

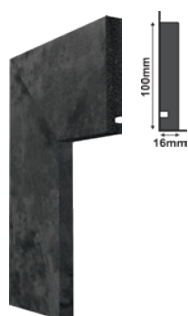

3547 GN OXI Preto
Door Case OXI Black
Contramarco OXI Negro
Cód. | Code - 28589

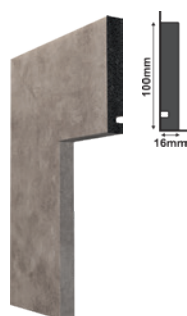

3547 GN OXI Prata
Door Case OXI Silver
Contramarco OXI Plata
Cód. | Code - 28590

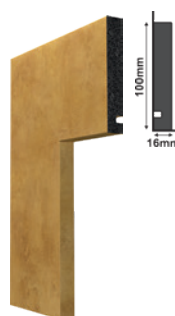

3547 GN OXI Ouro
Door Case OXI Gold
Contramarco OXI Oro
Cód. | Code - 28591

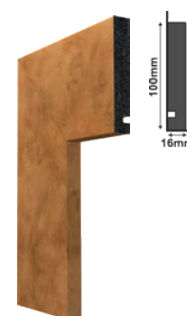

3547 GN OXI Ouro Rose
Door Case OXI Rose Gold
Contramarco OXI Oro Rosa
Cód. | Code - 28592

Produto | Product | Producto

① 3454 GN/Maple

② 3454 GN/Cumaru



Uma coleção composta de diferentes cores e texturas inspirados em madeiras nobres.

A collection composed of different colors and textures inspired by noble woods

Una colección compuesta de diferentes colores y texturas inspirados en maderas nobles.

Rodapés | Skirting Boards | Zócalos



3454 RP Ébano
Skirting Board Ebony | Zócalo Ebano
Cód. | Code - 26688



3454 RP Ipê Escuro
Skirting Board Dark Ipe | Zócalo Ipe Oscuro
Cód. | Code - 26690



3454 RP Cumaru
Skirting Board Base Cumaru | Zócalo Cumaru
Cód. | Code - 29287



3454 RP Maple
Skirting Board Maple | Zócalo Arce
Cód. | Code - 29289



3454 RP Pátina Branca
Skirting Board White Patina | Zócalo Patina Blanca
Cód. | Code - 29288

Guarniões | Door Casings | Contramarcos



3454 GN Ébano
Door Case Ebony
Contramarco Ebano
Cód. | Code - 26689



3454 GN Ipê Escuro
Door Case Dark Ipe
Contramarco Ipe Oscuro
Cód. | Code - 26691

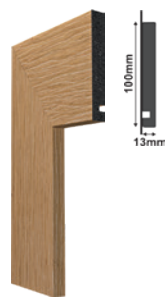

3454 GN Cumaru
Door Case Cumaru
Contramarco Cumaru
Cód. | Code - 29290

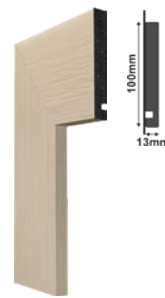

3454 GN Maple
Door Case Maple
Contramarco Arce
Cód. | Code - 29292

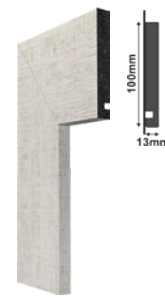

3454 GN Pátina Branca
Door Case White Patina
Contramarco Patina Blanca
Cód. | Code - 29291

Utilize Santa Luzia Massa Premium nas cores BRANCA, OURO, CARVALHO PRATA, IPÊ ESCURO ou PRETA para um acabamento perfeito.

Use Santa Luzia premium caulk in WHITE, GOLD, BLACK, DARK IPE or SILVER OAK for a perfect finish.
Utilice Santa Luzia masilla premium en BLANCO, ARCE, IPE OSCURO, NEGRO o ORO para un acabado perfecto.



Produto | Product | Producto

① 565 RP/Ébano

①

Coleção Natural

PRODUTO **SANTALUZIA**

Wood Collection | Colección Natural

Barra de 2,40m | 240 cm bars

Essa coleção amadeirada foi redesenhada para permitir ajustes perfeitos em qualquer tipo de piso, especialmente os laminados. Como o piso laminado tem contração maior que os demais pisos, a sua base com 18mm garante acabamento impecável.

This woody collection has been redesigned to allow perfect adjustments to any type of flooring, especially laminates. As the laminate flooring has greater contraction than other type of floors, the your baseboard with 11/16" guarantees impeccable finish.

Esta colección leñosa ha sido rediseñada para permitir ajustes perfectos a cualquier tipo de pisos, especialmente laminados. Como el suelo laminado tiene una mayor contracción que los otros pisos, el zócalo con 18mm garantiza un acabado impecable.

Rodapés | Skirting Boards | Zócalos



565 RP Ébano
Skirting Board Ebony | Zócalo Ebano
Cód. | Code - 28624



565 RP Ipê Escuro
Skirting Board Dark Ipe | Zócalo Ipe Oscuro
Cód. | Code - 28625



565 RP Canela
Skirting Board Cinnamon | Zócalo Canela
Cód. | Code - 28626



565 RP Cedro
Skirting Board Cedar | Zócalo Cedro
Cód. | Code - 28627



565 RP Pau Marfim
Skirting Board Ivory Wood | Zócalo Madera de Marfil
Cód. | Code - 28628



565 RP Carvalho Prata
Skirting Board Silver OAK | Zócalo Carvalho Plata
Cód. | Code - 28629

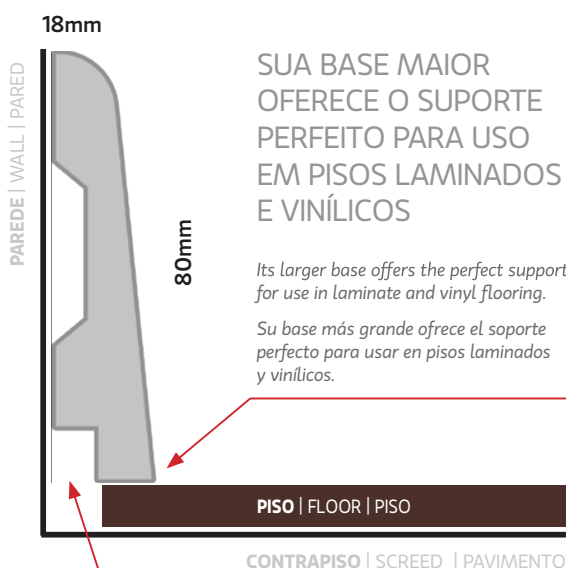

JUNTA DE DILATAÇÃO
Floor expansion joint
Junta de dilatación



Para acabamento utilize Massa Premium, Dupla face e Super adesivo Santa Luzia

Use Santa Luzia premium caulk, double sided tape and Santa Luzia Heavy Duty Adhesive for installation and perfect finish. Utilice Santa Luzia masilla premium, cinta doble cara y Super Pegatina Santa Luzia para instalación y acabado perfectos.

Rodapés | Skirting Boards | Zócalos



446 RP/NA-01
Skirting Board Natural 01 | Zócalo Natural 01
Cód. | Code -20108



446 RP/NA-02
Skirting Board Natural 02 | Zócalo Natural 02
Cód. | Code -20216



446 RP/NA-03
Skirting Board Natural 03 | Zócalo Natural 03
Cód. | Code -20217



446 RP/NA-04
Skirting Board Natural 04 | Zócalo Natural 04
Cód. | Code -20218



446 RP/NA-05
Skirting Board Natural 05 | Zócalo Natural 05
Cód. | Code -20219



446 RP/NA-06
Skirting Board Natural 06 | Zócalo Natural 06
Cód. | Code -20220



446 RP/NA-07
Skirting Board Natural 07 | Zócalo Natural 07
Cód. | Code -25557



Para acabamento do NA-01 utilizar massa PRATA, NA-02, NA-03, NA-04 e NA-07 utilizar massa OURO, NA-05 utilizar massa COBRE e NA-06 utilizar massa IPÊ ESCURO.

Para acabado NA01 utilice masila PLATA, NA-02, NA-03, NA-04 e NA-07 utilice masila ORO, NA-05 utilice masila COBRE y NA-06 utilice masila IPÊ OSCURO.

Produto | Product | Producto

1 446 RP/NA-05



Os tons amadeirados criam um clima acolhedor e confortável.

Tones of wood create a cozy and comfortable atmosphere.

Los tonos amaderados crean un clima acogedor y comfortable.

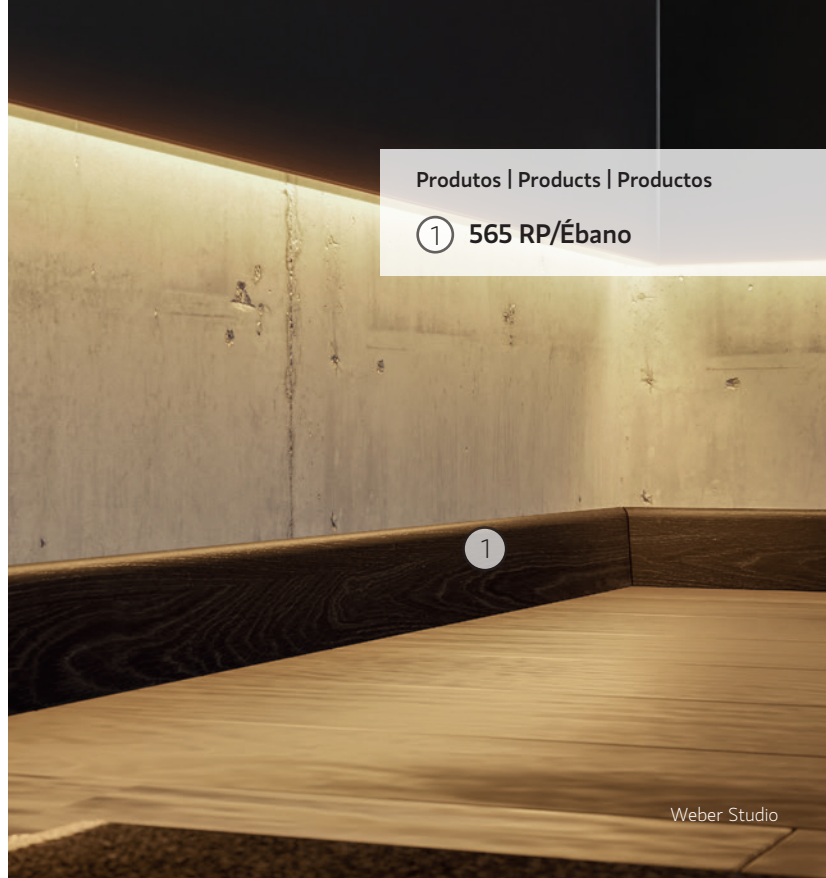

Weber Studio

Guarnições | Door Casings | Contramarcos



446 GN/NA 01
Door Case Natural 01
Contramarco Natural 01
Cód. | Code - 20221



446 GN/NA 02
Door Case Natural 02
Contramarco Natural 02
Cód. | Code - 20222

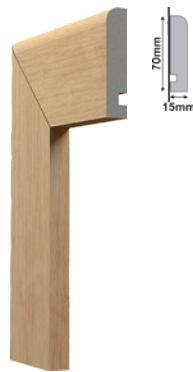

446 GN/NA 03
Door Case Natural 03
Contramarco Natural 03
Cód. | Code - 20223



446 GN/NA 04
Door Case Natural 04
Contramarco Natural 04
Cód. | Code - 20224



446 GN/NA 05
Door Case Natural 05
Contramarco Natural 05
Cód. | Code - 20225



446 GN/NA 06
Door Case Natural 06
Contramarco Natural 06
Cód. | Code - 20226



446 GN/NA 07
Door Case Natural 07
Contramarco Natural 07
Cód. | Code - 25745

Produto | Product | Producto

① 548 RP/Reforma

①

Linha Reforma

Refit Wall Line | Línea Reforma

Barras de 2,40m | 240 cm bars

São três tamanhos que podem ser sobrepostos ao rodapé antigo, com ajuste perfeito, inclusive em pisos laminados. É ideal para reformas, por sua praticidade e facilidade de instalação, que dispensa a retirada do rodapé substituído.

There are three sizes that can be covered fit over on the existing baseboard, with perfect fit. It is ideal for renovations, for its practicality and ease of installation, which does not require removal of the replaced baseboard.

Hay tres tamaños que pueden ser solapados en el zócalo actual, con ajuste perfecto, incluyendo pisos laminados. Es ideal para renovaciones, por su practicidad y facilidad de instalación, que no requiere la remoción del zócalo reemplazado.

Rodapés | Wall Baseboards | Zócalos



582 RP/BR Reforma
Refit Skirting Board White
Zócalo Blanco Reforma
Cod: 29298

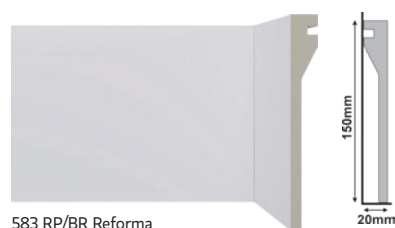

583 RP/BR Reforma
Refit Skirting Board White
Zócalo Blanco Reforma
Cod: 29299



548 RP/BR Reforma
Refit Skirting Board White
Zócalo Blanco Reforma
Cod: 27856

Sobreposição de até 10 cm de largura
Overlapping up to 10 cm wide
Sobreponiéndose hasta de ancho 10 cm

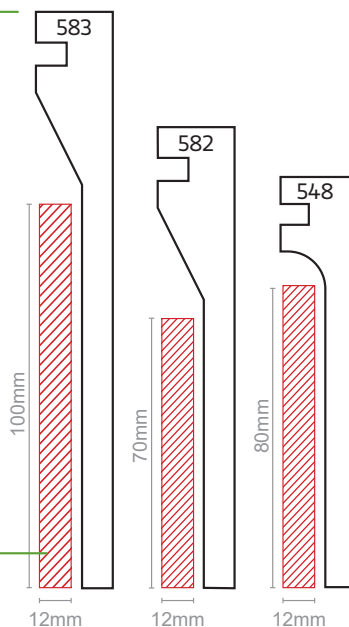

Rodapé antigo
Current Baseboard
Zócalo actual

SOBREPOSIÇÃO PERFEITA. FÁCIL, RÁPIDA E SEM SUJEIRA.

Perfect Overlap.
Easy, quick and dirtless.

Superposición perfecta.
Fácil, rápido y menos suciedad.



Utilize Santa Luzia Massa Premium na cor BRANCA, Fita Dupla Face e Super Adesivo Santa Luzia para instalação e acabamento perfeitos.

Use Santa Luzia WHITE premium caulk, Double Sided Tape and Santa Luzia Heavy Duty Adhesive for installation and perfect finish.

Utilize Santa Luzia masilla BLANCA premium, Cinta Doble Cara y Super Pegatina Santa Luzia para instalación y acabado perfectos.

Produto | Product | Producto

① 496 RP/Melodia do Mar

② 496 RP/Pistache



Weber Studio

coleção

COLORS

Colors Collection | Colección Colores

CRIATIVOS, SOFISTICADOS E OUSADOS.

CREATIVE, SOPHISTICATED AND BOLD.
CREATIVOS, SOPHISTICADOS Y AUDACES.

Tons criativos, sofisticados e ousados se reúnem em paleta que remonta os estudos de cor por Le Corbusier.

Uma Paleta Modernista que traz de volta, com nova roupagem, os tons poderosos e vibrantes que dominaram a estética entre os anos de 1930 e 1960.

Creative, sophisticated and bold tones come together in a palette that dates back to color studies by Le Corbusier. The Modernist Palette brings back, with new manifestation, the powerful and vibrant tones that dominated the aesthetics between the 30's and 60's.

Los tonos profundos, sofisticados y audaces se combinan en una paleta que se remonta a los estudios de color de Le Corbusier. La Paleta Modernista trae de vuelta, con una nueva manifestación, los tonos poderosos y vibrantes que dominaron la estética entre los años 30 y 60.

Barras de 2,40m | 240 cm bars

Rodapés | Skirting Boards | Zócalos



480 RP/Melodia do Mar
Melody of the Sea
Melodía del mar
Cód. | Code - 28918



480 RP/Eucalipto
Eucalyptus
Eucalipto
Cód. | Code - 28916



480 RP/Pistache
Pistachio
Pistacho
Cód. | Code - 28919



480 RP/Rupestre
Rock
Ruprestre
Cód. | Code - 28917



480 RP/Vermelho Escuro
Dark Red
Rojo Oscuro
Cód. | Code - 28915



480 RP/Tijolo
Brick
Ladrillo
Cód. | Code - 28914

Guarnições | Door Casings | Contramarcos

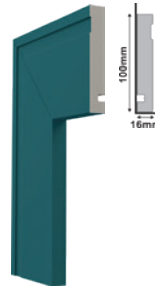

457 GN/Melodia do Mar
Melody of the Sea
Melodía del mar
Cód. | Code - 28912

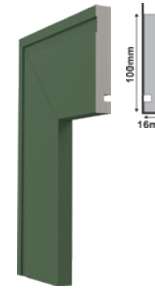

457 GN/Eucalipto
Eucalyptus
Eucalipto
Cód. | Code - 28910

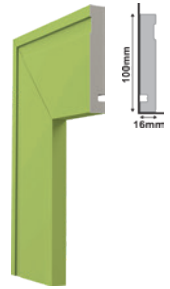

457 GN/Pistache
Pistachio
Pistacho
Cód. | Code - 28913

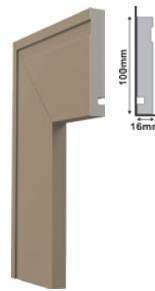

457 GN/Rupestre
Rock
Ruprestre
Cód. | Code - 28911

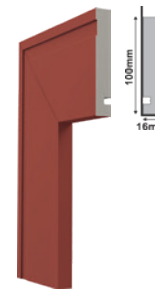

457 GN/Vermelho Escuro
Dark Red
Rojo Oscuro
Cód. | Code - 28909

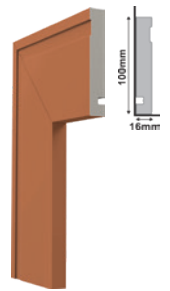

457 GN/Tijolo
Brick
Ladrillo
Cód. | Code - 28908

Rodapés | Skirting Boards | Zócalos



496 RP/Melodia do Mar
Melody of the Sea
Melodía del mar
Cód. | Code - 29017

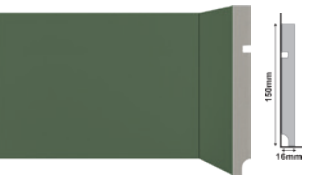

496 RP/Eucalipto
Eucalyptus
Cód. | Code - 29016



496 RP/Pistache
Pistachio
Pistacho
Cód. | Code - 29020



496 RP/Rupestre
Rock
Ruprestre
Cód. | Code - 29015



496 RP/Vermelho Escuro
Dark Red
Rojo Oscuro
Cód. | Code - 29019



496 RP/Tijolo
Brick
Ladrillo
Cód. | Code - 29018

Guarnições | Door Casings | Contramarcos

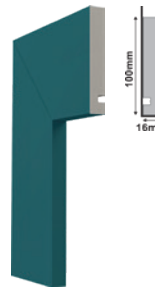

547 GN/Melodia do Mar
Melody of the Sea
Melodía del mar
Cód. | Code - 29023

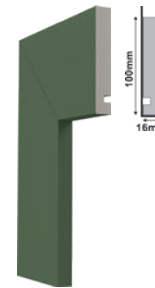

547 GN/Eucalipto
Eucalyptus
Eucalipto
Cód. | Code - 29022

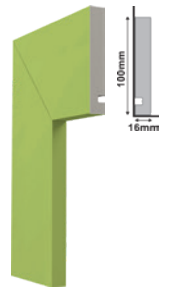

547 GN/Pistache
Pistachio
Pistacho
Cód. | Code - 29026

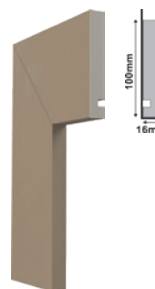

547 GN/Rupestre
Rock
Ruprestre
Cód. | Code - 29021

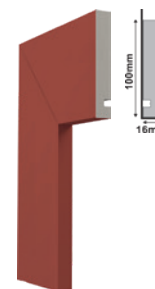

547 GN/Vermelho Escuro
Dark Red
Rojo Oscuro
Cód. | Code - 29025

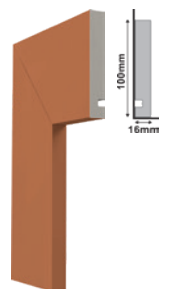

547 GN/Tijolo
Brick
Ladrillo
Cód. | Code - 29024



1

Produto | Product | Producto

1 Ripa + Filete Branco (Personalizado)

Coleção
MULTILINHA

Multiline Collection | Colección Multilinea

Barras de 2,80m | 280 cm bars

Multilinha é uma coleção formada por ripas em formato de peças estreitas e alongadas. Versáteis, permitem composições criativas em diferentes superfícies como paredes e móveis, podendo ser aplicadas tanto na vertical como na horizontal.

Multiline is a collection formed by ribs in the shape of narrow and elongated pieces. Versatile, they allow creative compositions on different surfaces such as walls & furniture and can be applied both vertically and horizontally.

Multilinea es una colección formada por listones en forma de piezas estrechas y alargadas. Versátil, permite composiciones creativas en diferentes superficies como paredes y muebles, y se puede aplicar tanto vertical como horizontalmente.

Ripas e Filetes

Pro Slatted Wall
Listones y Filetes



As Ripas de Poliestireno Santa Luzia são produtos versáteis que podem ser usados separadamente ou em conjunto com os Filetes de Poliestireno, permitindo composições de painéis ripados criativos e modernos com lindos efeitos de profundidade e sobreposição.

Santa Luzia's Polystyrene Pro Slatted Wall are versatile products that can be used separately or in conjunction with Polystyrene Pro Slatted Wall, allowing compositions of creative and modern ripped panels with beautiful effects of depth and overlap.

Los listones de poliestireno Santa Luzia son productos versátiles que se pueden utilizar por separado o en combinación con filetes de poliestireno, permitiendo composiciones de paneles alistonados, creativos y modernos, con hermosos efectos de profundidad y superposición.

Ripas | Pro Slatted Wall | Listones



Ripa 466 Preto
Pro Slatted Wall 466 Black
Listón 466 Negro
Cód. | Code - 29881



Ripa 466 Branco
Pro Slatted Wall 466 White
Listón 466 Blanco
Cód. | Code - 29880



Ripa 466 Cumaru
Pro Slatted Wall 466 Cumaru
Listón 466 Cumaru
Cód. | Code - 29873



Ripa 466 Curupixá
Pro Slatted Wall 466 Curupixá
Listón 466 Curupixá
Cód. | Code - 29875



Ripa 466 Ipê Escuro
Pro Slatted Wall 466 Dark Ipê
Listón 466 Ipe Oscuro
Cód. | Code - 29874



Ripa 466 Ébano
Pro Slatted Wall 466 Ebony
Listón 466 Ebano
Cód. | Code - 29876



Ripa 466 Prata
Pro Slatted Wall 466 Silver
Listón 466 Plata
Cód. | Code - 29860



Ripa 466 Ouro
Pro Slatted Wall 466 Gold
Listón 466 Oro
Cód. | Code - 29882



Ripa 466 Cobre
Pro Slatted Wall 466 Cooper
Listón 466 Cobre
Cód. | Code - 29883



Ripa 466 Oxi Prata
Pro Slatted Wall 466 Oxi Silver
Listón 466 Oxi Plata
Cód. | Code - 29879



Ripa 466 Oxi Ouro Rosê
Pro Slatted Wall 466 Oxi Rose Gold
Listón 466 Oxi Oro Rosa
Cód. | Code - 29877



Ripa 466 Oxi Ouro
Pro Slatted Wall 466 Oxi Gold
Listón 466 Oxi Oro
Cód. | Code - 29878

Filetes | Pro Slatted Wall | Filetes



Filete Preto
Pro Slatted Wall Black
Filete Negro
Cód. | Code - 29863



Filete Branco
Pro Slatted Wall White
Filete Blanco
Cód. | Code - 29862



Filete Cumaru
Pro Slatted Wall Cumaru
Filete Cumaru
Cód. | Code - 29855



Filete Curupixá
Pro Slatted Wall Curupixá
Filete Curupixá
Cód. | Code - 29857



Filete Ipê Escuro
Pro Slatted Wall Dark Ipê
Filete Ipe Oscuro
Cód. | Code - 29856



Filete Ébano
Pro Slatted Wall Ebony
Filete Ebano
Cód. | Code - 29858



Filete Prata
Pro Slatted Wall Silver
Filete Plata
Cód. | Code - 29866



Filete Ouro
Pro Slatted Wall Gold
Filete Oro
Cód. | Code - 29864



Filete Cobre
Pro Slatted Wall Cooper
Filete Cobre
Cód. | Code - 29865



Filete Oxi Prata
Pro Slatted Wall Oxi Silver
Filete Oxi Plata
Cód. | Code - 29861



Filete Oxi Ouro Rosê
Pro Slatted Wall Oxi Rose Gold
Filete Oxi Oro Rosa
Cód. | Code - 29859



Filete Oxi Ouro
Pro Slatted Wall Oxi Gold
Filete Oxi Oro
Cód. | Code - 29860

Tamanhos | Sizes | Tamaños:

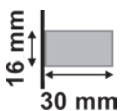

Ripas
Pro Slatted Wall
Listones

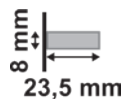

Filetes
Pro Slatted Wall
Filetes

PARA MELHORES EFEITOS DE PROFUNDIDADE E SOBREPOSIÇÃO, INDICAMOS A MONTAGEM INTERCALANDO UMA RIPA MAIS UM FILETE.

For better depth and overlapping effects, we recommend the assembly of both the Pro Slatted Wall.

Para mejores efectos de profundidad y superposición, indicamos el ensamblado intercalando un listón mas un filete.

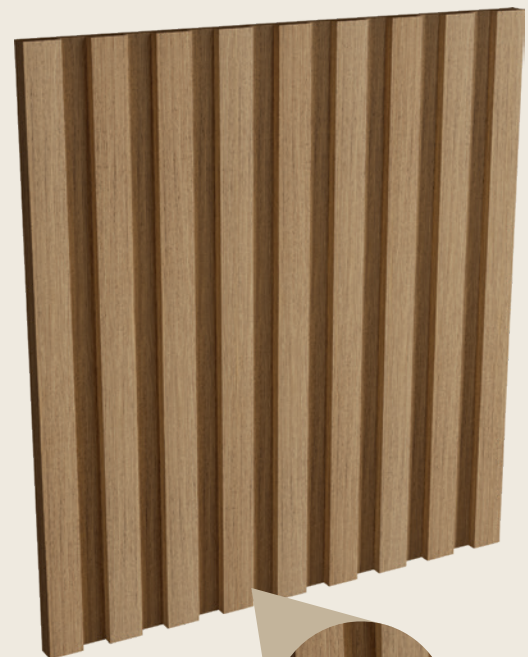

RIPAS

FILETES

Ripados de Encaixe

DIY Slatted Boards
Listones de Encaje



O Ripado de Encaixe é a união entre as Ripas e Filetes de Poliestireno em uma única peça. São disponibilizados em dois tamanhos com 55 e 75 mm de largura. O encaixe é preciso, oferecendo instalação mais rápida, fácil e acabamento impecável.

The DIY Slatted Wall is the union between the Polystyrene Battens in a single piece. They are available in two sizes, 55 and 75 mm wide. The fit is precise, offering quicker and easier installation and impeccable finishing.

El panel alistonado es la unión entre los Listones y los filetes de Poliestireno en una sola pieza. Están disponibles en dos tamaños de 55 y 75 mm de ancho. El ajuste es preciso, ofreciendo una instalación más rápida y fácil y un acabado impecable.

Produtos | Products | Productos

55 mm x 16 mm x 2,80 m



Ripado 55 Preto
DIY Slatted Wall 55 Black
Listón 55 Negro
Cód. | Code - 21352



Ripado 55 Branco
DIY Slatted Wall 55 White
Listón 55 Blanco
Cód. | Code - 21353



Ripado 55 Cumarú
DIY Slatted Wall 55 Cumarú
Listón 55 Cumarú
Cód. | Code - 21354



Ripado 55 Curupixá
DIY Slatted Wall 55 Curupixá
Listón 55 Curupixá
Cód. | Code - 21355



Ripado 55 Ipê Escuro
DIY Slatted Wall 55 Dark Ipe
Listón 55 Ipe Oscuro
Cód. | Code - 21356



Ripado 55 Ébano
DIY Slatted Wall 55 Ebony
Listón 55 Ebano
Cód. | Code - 21357

75 mm x 16 mm x 2,80 m



Ripado 75 Preto
DIY Slatted Wall 75 Black
Listón 75 Negro
Cód. | Code - 21358

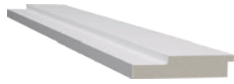

Ripado 75 Branco
DIY Slatted Wall 75 White
Listón 75 Blanco
Cód. | Code - 21359



Ripado 75 Cumarú
DIY Slatted Wall 75 Cumarú
Listón 75 Cumarú
Cód. | Code - 21360



Ripado 75 Curupixá
DIY Slatted Wall 75 Curupixá
Listón 75 Curupixá
Cód. | Code - 21361



Ripado 75 Ipê Escuro
DIY Slatted Wall 75 Dark Ipe
Listón 75 Ipe Oscuro
Cód. | Code - 21362



Ripado 75 Ébano
DIY Slatted Wall 75 Ebony
Listón 75 Ebano
Cód. | Code - 21363



**ENCAIXE PRECISO
ACABAMENTO IMPECÁVEL**

Precise fit, impeccable finish

Ajuste preciso, acabado impecable

Tamanhos | Sizes | Tamaños:

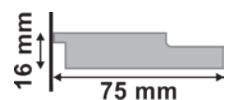
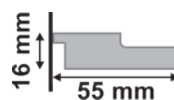

Ripas Pinus

Yellow Pine Slatted Wall
Listones de Pino



A madeira natural garante um ótimo resultado para um painel ripado, onde normalmente se utiliza ripas em tons mais claros para não 'carregar' os ambientes. Com a Coleção Multilinha, a Santa Luzia oferece ripas produzidas com pinus de reflorestamento. Para garantir um aspecto ainda mais natural, a empresa preserva os nós da madeira.

The natural wood guarantees a great result for a ripped panel, where Slatted Wall in lighter tones are normally used to not "weigh down" environments. To ensure an even more natural look, the company preserves the wood knots.

La madera natural garantiza un gran resultado para un panel alistonado, donde los listones se utilizan generalmente en tonos más claros para no 'cargar' los ambientes. Con la Colección Multilínea Santa Luzia ofrece listones producidos con pinos de reforestación tratada. Para garantizar un aspecto aún más natural, la empresa conserva los nudos de la madera.

O CHARME DA MADEIRA NATURAL

THE CHARM OF
NATURAL WOOD

EL ENCANTO DE LA
MADERA NATURAL

Produtos | Products | Productos



Ripa Pinus 50x28
Yellow Pine Slatted Wall 50x28
Listón de Pino 50x28
Cód. | Code - 29803

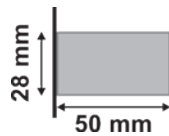

Ripa Pinus 28x28
Yellow Pine Slatted Wall 28x28
Listón de Pino 28x28
Cód. | Code - 29804

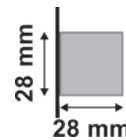

Ripa Pinus 14x28
Yellow Pine Slatted Wall 14x28
Listón de Pino 14x28
Cód. | Code - 29802

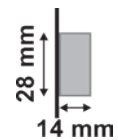

Weber Studio

Produto | Product | Producto

① Ripa Pinus 50x28

①

Produto | Product | Producto

① Ecodeck Imbuia

①

Weber Studio

WPC Deck Line | Línea Ecodeck

A coleção de ecodecks foi revitalizada, passando a contemplar os formatos Mini e Maxi. O espaçamento entre as placas foi reduzido a 3 mm, reduzindo possíveis danos aos calçados de salto fino. Fabricados em WPS, os produtos estão disponíveis na marcante cor imbuia para aplicações em áreas externas e internas, como em área de piscina.

The WPC Deck collection was revitalized, now including Mini and Maxi formats. The spacing between the plates was reduced to 3 mm, reducing possible damage to thin heeled shoes. Manufactured in WPS, the products are available in a striking imbuia color for applications in outdoor and indoor areas, such as in the pool area.

La colección de Ecodeck se revitalizó, contemplando ahora los formatos Mini y Maxi. El espacio entre las placas se redujo a 3 mm, reduciendo el posible daño a los calzados de tacón delgado. Fabricados en WPS, los productos están disponibles en llamativo color Imbuia para aplicaciones en áreas externas e internas, como puede ser el área de la piscina.

Produtos | Products | Productos

MAXIDECK

Barra | Bar | Barra 240 x 12,5 x 2,4 cm



Maxideck Imbuia | Brazilian Walnut | Imbuia
Cód. | Code - 21349

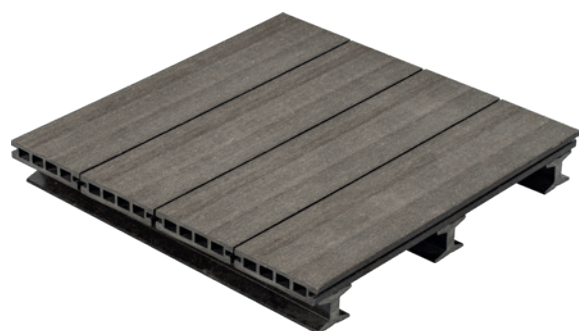

Simulação de aplicação do Maxideck

MINIDECK

Barra | Bar | Barra 240 x 5,8 x 2,4 cm



Minideck Imbuia | Brazilian Walnut | Imbuia
Cód. | Code - 21348

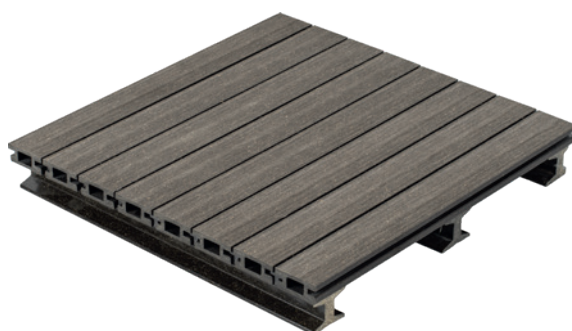

Simulação de aplicação do Minideck

- Fácil de instalar | Easy to install | Fácil de instalar
- Não necessita de pintura | No painting needed | No requiere pintura
- Uso interno e externo | Internal and external use | Uso interno e externo

Barrotes | Bars | Barrotes
240 x 5,4 x 4,4cm

Clipes de Fixação
Fixation Clips
Clip de Fijación



Barrote | Bar | Barrote
Imbuia | Brazilian Walnut | Imbuia
Cód. | Code - 26185

Grampo | Clip | Clip
Imbuia | Brazilian Walnut | Imbuia
Cód. | Code - 27970

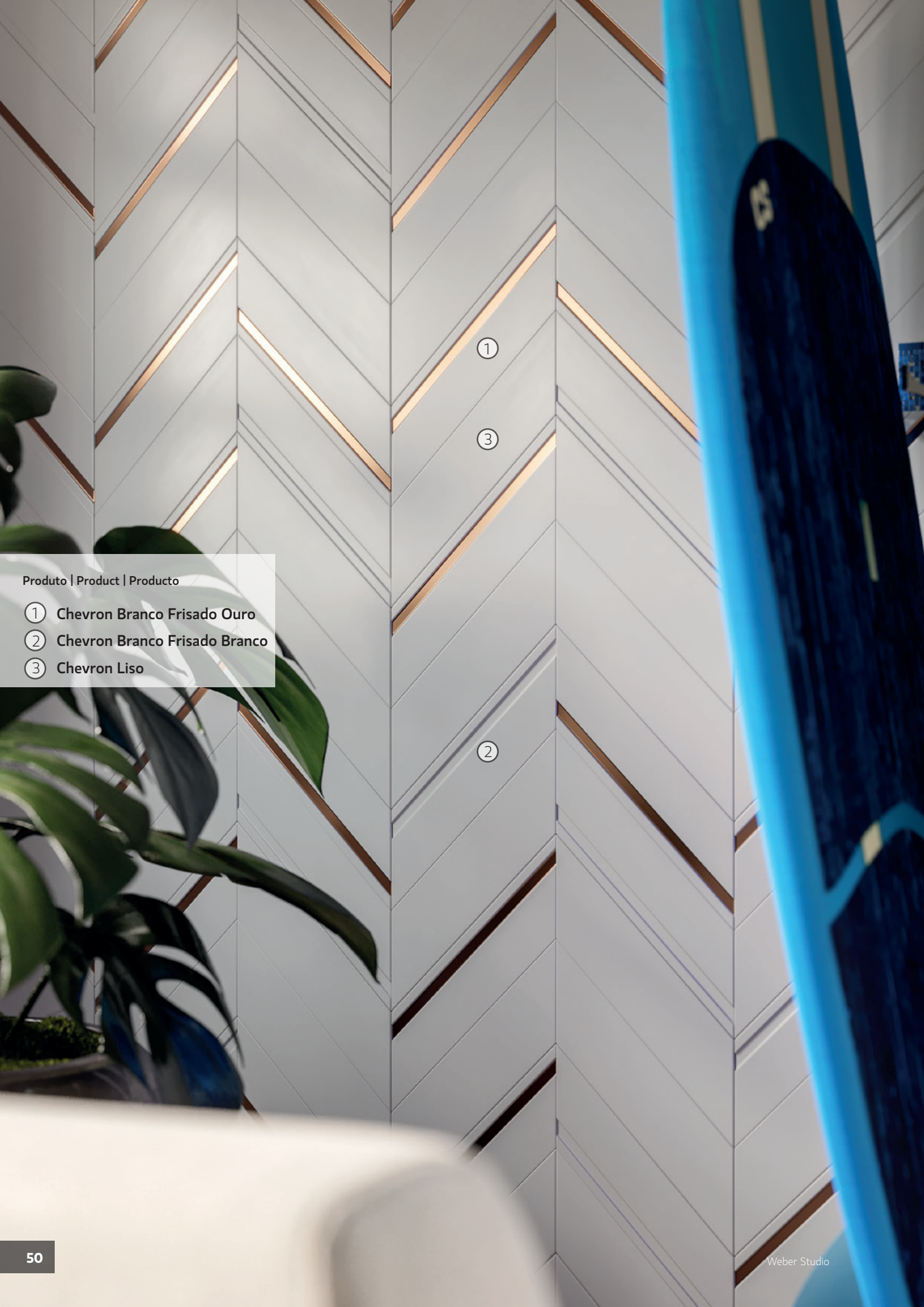

Produto | Product | Producto

- ① Chevron Branco Frisado Ouro
- ② Chevron Branco Frisado Branco
- ③ Chevron Liso

Coleção Chevron

PRODUTO
SANTALUZIA

Peças com 350 x 70 x 8 mm

É possível encontrá-lo há milênios, mas foi por meio da grife italiana Missoni que o grafismo Chevron, o popular "espinha de peixe", imortalizou-se no imaginário de gerações e gerações adiante. A famosa paginação em zigue-zague é apenas uma das possibilidades da nova coleção de revestimentos de parede da Santa Luzia, feito de PS reciclado e disponíveis em oito cores.

It has been around for millennia, but it was through the Italian brand Missoni that the Chevron graphics, the popular "fishbone", immortalized itself in the imagination of generations and generations ahead. The famous zigzag pagination is just one of the possibilities of Santa Luzia's new collection of wall coverings, made from recycled Polystyrene and available in eight colors.

Es posible encontrarlo durante milenios, pero fue a través de la marca italiana Missoni que el gráfico de Chevron, o la popular "aleta de pez", se immortalizó en la imaginación de generaciones y generaciones. La famosa formación en zigzag es solo una de las posibilidades de la nueva colección de revestimientos de paredes de Santa Luzia, hecha de PS reciclado y disponible en ocho colores.

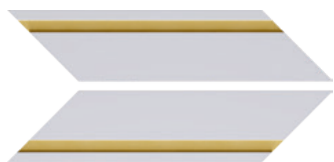

CHEVRON
Branco Frisado Ouro
White Milled Gold
Blanco con friso oro
Cod: 21346



CHEVRON
Branco Frisado Cobre
White Milled Copper
Blanco con friso Cobre
Cod: 21347

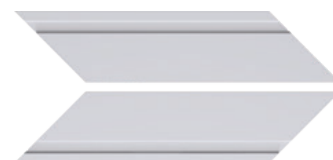

CHEVRON
Branco Frisado Branco
White Milled White
Blanco con friso Branco
Cod: 21345



CHEVRON
Preto Liso
Smooth Black
Negro Liso
Cod: 21344



CHEVRON
Rupestre Liso
Smooth Rock
Rupestre Liso
Cod: 21342

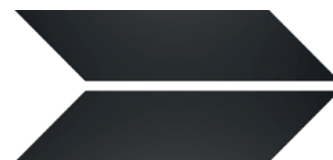

CHEVRON
Cinza Liso
Smooth Graphite Gray
Gris Grafito
Cod: 21343

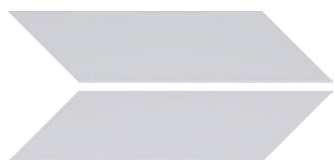

CHEVRON
Branco Liso
Smooth White
Blanco liso
Cod: 21340

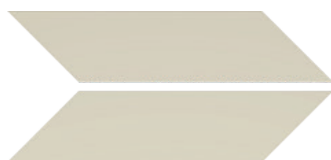

CHEVRON
Algodão Egípcio Liso
Smooth Egyptian Cotton
Algodón Egípcio liso
Cod: 21341

Aplicações

A coleção Chevron traz diferentes possibilidades ao seu ambiente, com seu formato angular, pode se criar padrões modernos que deixarão seus ambientes luxuosos.

The Chevron collection brings different possibilities to your environment, with its angular shape, you can create modern patterns that will make your environments luxurious.

La Colección Chevron trae diferentes posibilidades de creacion en su ambiente, con su formato angular permite hacer combinaciones modernas que dejaran sus ambientes lujosos

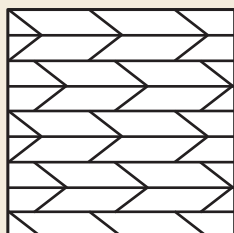

Chevron Seta
Indicator Chevron
Chevron Zeta

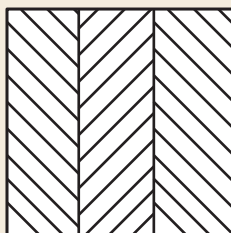

Chevron Flecha
Arrow Chevron
Chevron Flecha

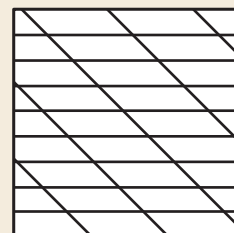

Chevron Diagonal
Diagonal Chevron
Chevron Diagonal

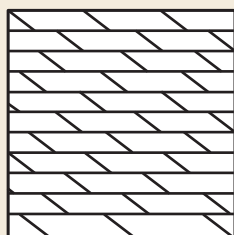

Chevron Desalinado
Messy Chevron
Chevron Desalineado

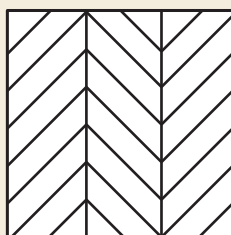

Chevron Tradicional
Traditional Chevron
Chevron Tradicional

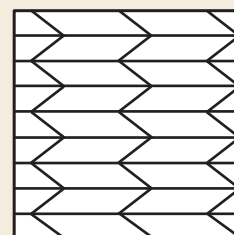

Chevron Seta Alinhada
Aligned Indicator Chevron
Chevron Zeta Alineado

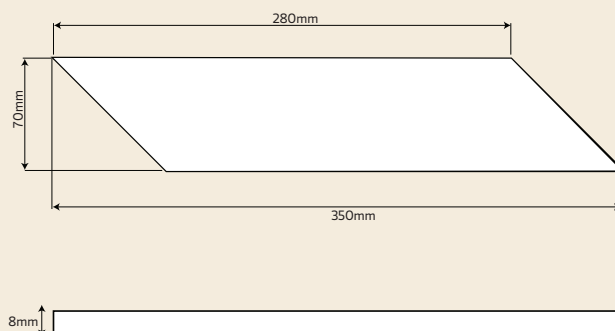

Produto | Product | Producto

- ① Chevron Branco Frisado Ouro
- ② Chevron Branco Frisado Branco
- ③ Chevron Liso Branco





Produto | Product | Producto

① Chevron Liso Ruprestre

Produto | Product | Producto

① 547 RP/BR

② Woodpanel Branco



Produto | Product | Producto

- ① WoodPanel Castanho
- ② WoodPanel Castanho Claro
- ③ WoodPanel Castanho Escuro

Ideal para quem gosta de renovar a casa no melhor estilo faça-você-mesmo, a Wood Panel é composta por placas de madeira oriunda de Pinus reflorestado em seis cores com diferentes acabamentos. A instalação é fácil em paredes inteiras, painéis de TV e cabeceiras de cama, por exemplo, tornando ambientes mais aconchegantes.

Ideal for those who like to renovate the house in the best do-it-yourself style, the Wood Panel Collection is composed of wooden panels in six colors

Ideal para quienes gustan de renovar la casa en el mejor estilo DIY (bricolaje), el Wood Panel se compone de tablas de madera en pino reflorestado, en seis colores, con diferentes acabados. La instalación es fácil en paredes enteras, paneles de TV y cabeceras, por ejemplo, haciendo que los ambientes sean más acogedores. Placas de pino reforestado en seis colores.

WOODPANEL Azul

Blue | Azul

Cód. | Code - 21391

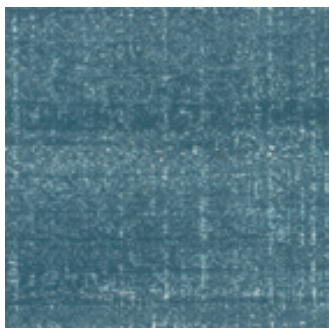

WOODPANEL Branco

White | Blanco

Cód. | Code - 21364



WOODPANEL Preto

Black | Negro

Cód. | Code - 31395

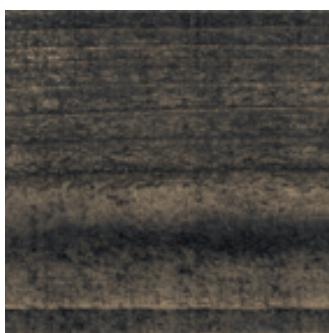

WOODPANEL Castanho Escuro

Dark Brown | Castaño Oscuro

Cód. | Code - 21394

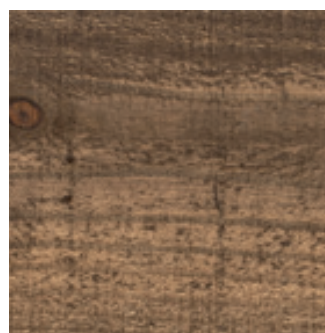

WOODPANEL Castanho

Brown | Castaño

Cód. | Code - 21393



WOODPANEL Castanho Claro

Light Brown | Castaño Claro

Cód. | Code - 21392



Applications

A beleza rustica da madeira que possibilita a criação de painéis em diversos ambientes, com padrões diferenciados agregando personalidade ao seu lar.

The Chevron collection brings different creation possibilities to your environment, with its angular shape, you can create modern patterns that will make your environments luxurious.

La belleza de la madera rustica que possibilita la creacion de paneles en diferentes ambientes , con diversas combinaciones agregando personalidad al espacio.

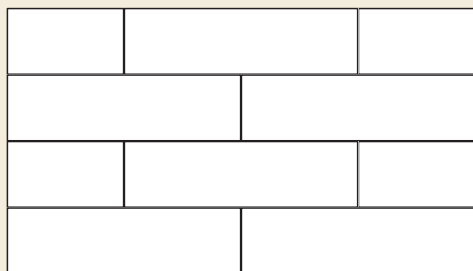

Painel Horizontal

Horizontal Panel
Panel Horizontal

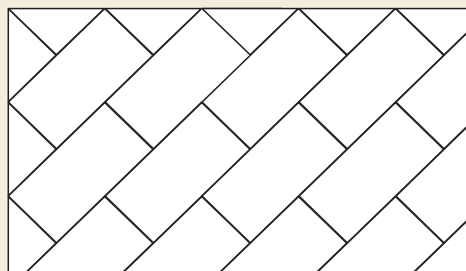

Painel Diagonal

Diagonal Panel
Panel Diagonal

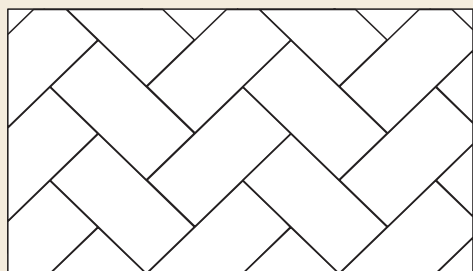

Painel Espinha-de-Peixe

Herringbone Panel
Panel Espina de Pez

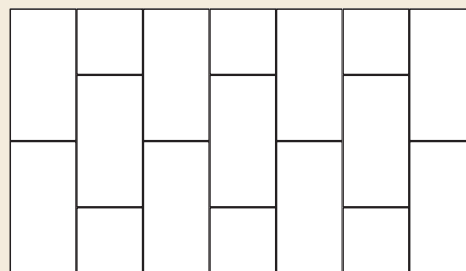

Painel Vertical

Vertical Panel
Panel Vertical

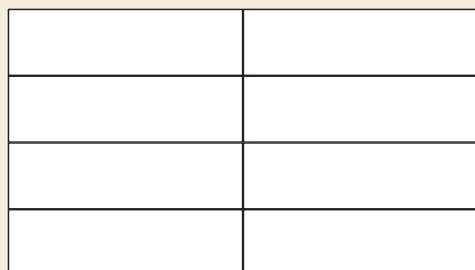

Painel Alinhado

Aligned Panel
Panel Alineado

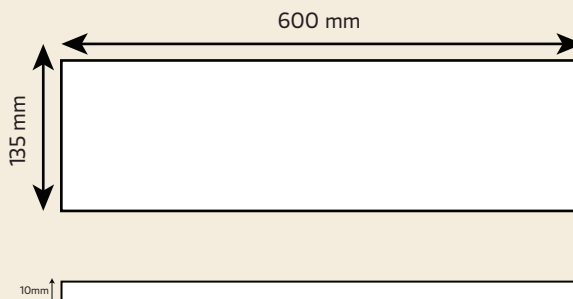



Produto | Product | Producto

- ① WoodPanel Azul
- ② Ecodeck Maxi

①

②

Acessórios

Accessories | Accesorios

A Santa Luzia desenvolveu soluções completas para instalação e complementação de seu mix de perfis e revestimentos, afinal, não basta um rodapé ser bonito se o adesivo que vai fixá-lo não for de qualidade. A empresa desenvolveu uma abrangente coleção de fixadores como o Super Adesivo (branco ou incolor), Calafetador, Colas Convencional e Instantânea e Fita Dupla Face, facilitando a vida do instalador. O acabamento perfeito é garantido por meio das Massas Premium e Terminais de Acabamento (centro, topo, interno e externo) para ocultar emendas, cortes e junções.

Santa Luzia has developed complete solutions for installing and complementing its mix of profiles and wall coverings, after all, it is not enough for a baseboard to be beautiful if the adhesive that is going to fix it is not of great quality. The company has developed a comprehensive collection of fasteners with Super Adhesive (white or colorless), Sealants, Conventional and Instant Glues and Double Sided Tape, making the installer's life easier. The perfect finish is guaranteed with the use of Premium Caulk and/or Finishing Terminals (center, top, internal and external) to hide seams, cuts and joints.

Santa Luzia ha desarrollado soluciones completas para instalar y complementar su mix de perfiles y revestimientos, después de todo, no es suficiente para que un pie zócalo sea hermoso si el adhesivo que lo arreglará no es de calidad. La compañía ha desarrollado una completa colección de fijadores con súper adhesivo (blanco o incoloro), Calafetador, colas Convencionales e instantaneas y cintas bifaz, facilitando la vida del instalador. La terminación perfecta está garantizada a través de las Masas Premium y Terminales de terminación (centro, superior, interno y externo) para ocultar costuras, cortes y juntas.

SUPER ADESIVO

Heavy Duty Adhesive | Super Pegatina



Super Adesivo |
Heavy Duty Adhesive
Super Pegatina

Embalagens | Package | Embaje:
Branco | White | Blanco - 400g
Cod. Code: 28934
Incolor | Colorless | Incolora - 280g
Cod. Code: 21267

COLA SUPER INSTANTÂNEA

Instant Glue | Pegamento Instantâneo



**EXCLUSIVO PARA USO EM
PERFIS DE POLIESTIRENO
SANTA LUZIA.**

**EXCLUSIVE FOR SANTA LUZIA'S
POLYSTYRENE PROFILES ONLY**

**EXCLUSIVO PARA USO EN PERFILES
DE POLIESTIRENO SANTA LUZIA.**

Cola Super Instantânea
Embalagem | Package | Embaje
100g
Cod. Code: 21211

COLA

Glue | Pegamento



Cola | Glue | Pegamento
Embalagens | Package | Embaje
400g - Cod. Code: 21073
1 Kg - Cod. Code: 26061
3 Kg - Cod. Code: 28647
5 Kg - Cod. Code: 21311

CALAFETADOR BASE D'ÁGUA

Caulk | Cafafeteador



Calafetador
Caulk
Calafeteador
Embalagens | Package | Embaje
400g
Cod. Code: 28988

- **FLEXÍVEL**
- **NÃO AMARELA**
- **CONTÉM FUNGICIDA**
- **USO INTERNO E EXTERNO**

- Flexible
- Non Yellowing
- Contains Fungicide
- Internal and external use
- Flexible
- No Amarillo
- Contiene Fungicida
- Uso interno y externo



MASSA PREMIUM

Caulk Santa Luzia | Masilla Santa Luzia

SÃO 15 CORES PARA UM PERFEITO ACABAMENTO

15 colors for a perfect finish | 15 colores para un acabado perfecto



Branca 90g e 340g
White | Blanco 90g and 340g

Coloridas 90g
Colored | Coloridas 90g

27008 - Branca | White | Blanco - 340 gr | 12 unid. | 12 units | 12 unidades
27009 - Branca | White | Blanco - 90 gr | 3,14 oz - 36 unid. | 36 units | 36 unidades
27010 - Preta | Black | Negro - 90 gr | 3,14 oz - 36 unid. | 36 units | 36 unidades
27011 - Preta | Black | Negro - 90 gr | 3,14 oz - 6 unid. | 6 units | 6 unidades
27012 - Ouro | Gold | Oro - 90 gr | 3,14 oz
27013 - Prata | Silver | Plata - 90 gr | 3,14 oz
27014 - Cobre | Cooper | Cobre - 90 gr | 3,14 oz
27015 - Carvalho Prata | Silve OAK | Carvalho Plata - 90 gr | 3,14 oz
27016 - Ipê Escuro | Dark Ipe | Ipe Oscuro - 90 gr | 3,14 oz
27089 - Branca | White | Blanca - 90 gr | 3,14 oz
27723 - Cinza Glacial | Glacial Gray | Gris Glacial - 90 gr | 3,14 oz
27724 - Cinza Titanium | Titanium Gray | Gris Titano - 90 gr | 3,14 oz
28979 - Tijolo | Brick | Ladrillo - 90 gr | 3,14 oz
28978 - Vermelho Escuro | Dark Red | Rojo Oscuro - 90 gr | 3,14 oz
28975 - Eucalipto | Eucalyptu | Eucalipto - 90 gr | 3,14 oz
28977 - Rupestre | Rock | Rupestre - 90 gr | 3,14 oz
28974 - Melodia do Mar | Melody of the Sea | Moldia del Mar - 90 gr | 3,14 oz
28976 - Pistache | Pistachio | Pistacho - 90 gr | 3,14 oz

FITA DUPLA FACE

Double sided tape | Cinta Doble Cara

Fita de Espuma de Poliuretano

Polyurethane foam tape

Cinta de espuma de poliuretano



Caixas de 2 e 10 metros
2 or 10 m boxes
Cajas de 2 o 10 metros
2 - Cod. | Code: 28202
10 - Cod. | Code: 28201

CLIP ECODECK

Ecodeck Clip | Clip Ecodeck

3 cores - Imbuia

3 colors - Brazilian Walnut

3 colores - Imbuia



Pacote com 30 unidades
Package with 30 units
Embaje con 30 unidades
Cod. | Code: 27970

BUCHA T

T Bracket | Tarugo T

Acompanha prego de aço 13x15 sem cabeça

Comes with headless steel nails 13x15

Incluye clavo de acero sin cabeza 13x15



Pacote com 30/50/100 unidades
Package with 30/50/100 units
Embaje con 30/50/100 unidades
30 - Cod. | Code: 26039
50 - Cod. | Code: 26040
100 - Cod. | Code: 26041

Acessórios

Accessories | Accesorios

TERMINAL DE TOPO

Top corner guard | Guardia de topo



PRODUZIDO EM PU (POLIURETANO) RECICLADO

NOVAS ALTURAS

Para rodapés com 20 e 25 cm de altura.

MARCAÇÕES PARA CORTE CONFORME O RODAPÉ

Cutting marking according to the baseboard.
Marca de corte según el zócalo.

RP	TR
50mm	55mm
70mm	75mm
80mm	85mm
100mm	105mm
150mm	155mm

RP - Rodapé | Baseboard | Zócalo
TR - Terminal | corner guard | Guardia

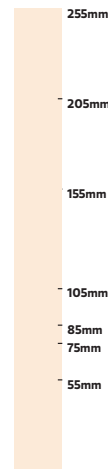

255 mm - 10 1/16"
20 mm
13/16"

Pacotes com 04 unidades
Package with 04 units
Embaje con 04 unidades
155 mm - Cod. | Code: 27925
205 mm - Cod. | Code: 21350
255 mm - Cod. | Code: 21351

TERMINAIS DE ACABAMENTO

Finishing Corner | Guardia de topo

Terminal para Canto Externo
Outer Corner Guard
Guardia de Esquina Exterior

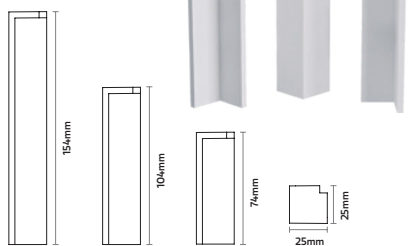

Terminal de Centro
Corner Guard
Guardia de Centro

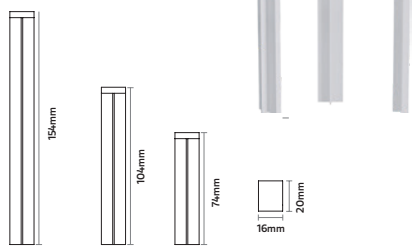

Terminal para Canto Interno
Inner Corner Guard
Guardia de Esquina Interior

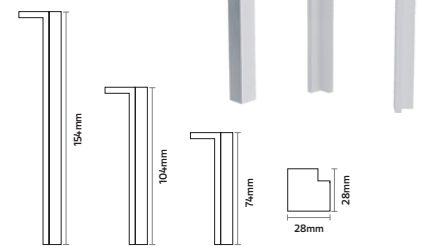

Cores | Colors | Colores

Coloridos | Colored | Coloridos: 15 cm

- 29040 - Rupestre | Rock | Rupestre
- 29037 - Eucalipto | Eucalyptus | Eucalipto
- 29038 - Melodia do Mar | Melody of the Sea | Melodia del Mar
- 29030 - Tijolo | Brick | Ladrillo
- 29041 - Vermelho Escuro | Dark Red | Rojo Oscuro
- 29039 - Pistache | Pistachio | Pistacho

Branco | White | Blanco

- 28752 - Branco | White | Blanco - 7 cm
- 28593 - Branco | White | Blanco - 10 cm
- 28753 - Branco | White | Blanco - 15 cm

Coloridos | Colored | Coloridos: 15 cm

- 29035 - Rupestre | Rock | Rupestre
- 29032 - Eucalipto | Eucalyptus | Eucalipto
- 29033 - Melodia do Mar | Melody of the Sea | Melodia del Mar
- 29029 - Tijolo | Brick | Ladrillo
- 29036 - Vermelho Escuro | Dark Red | Rojo Oscuro
- 29034 - Pistache | Pistachio | Pistacho

Branco | White | Blanco

- 28756 - Branco | White | Blanco - 7 cm
- 28594 - Branco | White | Blanco - 10 cm
- 28757 - Branco | White | Blanco - 15 cm

Coloridos | Colored | Coloridos: 15 cm

- 29045 - Rupestre | Rock | Rupestre
- 29042 - Eucalipto | Eucalyptus | Eucalipto
- 29043 - Melodia do Mar | Melody of the Sea | Melodia del Mar
- 29031 - Tijolo | Brick | Ladrillo
- 29046 - Vermelho Escuro | Dark Red | Rojo Oscuro
- 29044 - Pistache | Pistachio | Pistacho

Branco | White | Blanco

- 28754 - Branco | White | Blanco - 7 cm
- 28595 - Branco | White | Blanco - 10 cm
- 28755 - Branco | White | Blanco - 15 cm

Cores sob encomenda | Customized colors | Colores hechos a pedido: Cinzas | Grays | Grises

Cinza Glacial e Cinza Titanium | Glacial Gray and Titanium Gray | Gris Glacial y Gris Titano

- 21643 - Cinza Glacial | Glacial Gray | Gris Glacial - 7 cm
- 21645 - Cinza Glacial | Glacial Gray | Gris Glacial - 10 cm
- 21614 - Cinza Glacial | Glacial Gray | Gris Glacial - 15 cm
- 21644 - Cinza Titanium | Titanium Gray | Gris Titano - 7 cm
- 21646 - Cinza Titanium | Titanium Gray | Gris Titano - 10 cm
- 21616 - Cinza Titanium | Titanium Gray | Gris Titano - 15 cm

- 21639 - Cinza Glacial | Glacial Gray | Gris Glacial - 7 cm
- 21641 - Cinza Glacial | Glacial Gray | Gris Glacial - 10 cm
- 21612 - Cinza Glacial | Glacial Gray | Gris Glacial - 15 cm
- 21640 - Cinza Titanium | Titanium Gray | Gris Titano - 7 cm
- 21642 - Cinza Titanium | Titanium Gray | Gris Titano - 10 cm
- 21613 - Cinza Titanium | Titanium Gray | Gris Titano - 15 cm

- 21647 - Cinza Glacial | Glacial Gray | Gris Glacial - 7 cm
- 21649 - Cinza Glacial | Glacial Gray | Gris Glacial - 10 cm
- 21617 - Cinza Glacial | Glacial Gray | Gris Glacial - 15 cm
- 21648 - Cinza Titanium | Titanium Gray | Gris Titano - 7 cm
- 21650 - Cinza Titanium | Titanium Gray | Gris Titano - 10 cm
- 21618 - Cinza Titanium | Titanium Gray | Gris Titano - 15 cm

SUA CALCULADORA DE RENDIMENTOS

Criamos uma calculadora de rendimentos, onde você pode verificar qual a quantidade de material será usada na instalação dos produtos, no seu ambiente.

Utilizando as especificações de sua obra, você consegue ter a indicação de qual o melhor acessório da Santa Luzia para esse processo.

Acesse o Código QR e facilite sua compra!



ACOMPANHE PASSO A PASSO **COMO É FÁCIL INSTALAR** OS PRODUTOS SANTA LUZIA



Leia o Código QR e acompanhe o canal





Matriz | Headquarter | Sede

Rua Heriberto Efftting, 555 - Bairro Santa Luzia
CEP 88750-000 - Braço do Norte - SC - Brasil

Showroom Brasil

Edifício Thera Offices Faria Lima - Conj. 1503
Rua Pais Leme, 215 - Pinheiros - CEP 05424-150
São Paulo - SP - Brasil

Telefone/Phone/Teléfono: +55 (48) 3651-1300



Conheça todos os nossos produtos em:
Find all our products:
Conozca todos nuestros productos:

www.industriasantaluzia.com.br

 /santaluziarodapes

 @santa.luzia

 /industria.santaluzia

 blog.santaluziamolduras.com.br



Conheça todos os nossos produtos em:
Find all our products:
Conozca todos nuestros productos:

www.santaluzia.com.ar

 /santaluziarodapes

 @santaluziaarg

 /industria.santaluzia



Conheça todos os nossos produtos em:
Find all our products:
Conozca todos nuestros productos:

www.santaluziamouldings.eu

 /santaluziarodapes

 @santaluziamouldings.eu

 /santaluziamouldings.eu

 blog.santaluziamouldings.com